

***InfraScan***<sup>®</sup> **4000**

**4000/10**

**4000/10M**

**Series B**

With ***BeamStream*** and

***Digital Signal Equalization***

**User's Manual**

© Sitronic GmbH

# Contents

1.	DESCRIPTION .....	4
1.1	Working Principle .....	4
1.1.1	Parallel Scanning .....	4
1.1.2	Double Scanning (enhanced resolution) .....	6
1.2	System Description and Definitions .....	7
1.3	Maintenance .....	8
1.4	Scope of Supply .....	8
2.	PRODUCT SELECTION .....	9
2.1	Measuring accuracy and cycle time parallel scanning .....	9
2.2	Measuring accuracy and cycle time double scanning .....	10
2.3	Distance Ranges (Variable Gain).....	10
2.4	Ordering Code.....	11
3.	MOUNTING and COMMISSIONING.....	13
3.1	Mechanical Preparations .....	13
3.2	Electrical Connection .....	14
3.3	Adjusting.....	15
3.4	How to Earth the System.....	16
3.5	Hints Regarding Mounting.....	17
4.	FIRMWARE OPTIONS .....	20
4.1	Setting of measuring distance .....	20
4.2	Special Settings .....	22
4.3	Active Scan Area .....	23
4.4	Valid Data (Threshold) .....	24
4.5	Smoothing.....	24
4.6	Output Formats and Coding.....	27
4.6.1	DATA/POSITION - Normal .....	27
4.6.2	DATA/POSITION - Over All .....	28
4.6.3	DATA/POSITION - Largest Blocked Area .....	28
4.7	Output Mode Beams/mm.....	29
4.8	Remote Diagnosis (Error Messages) .....	29
4.9	Original Configuration .....	29
5.	OUTPUTS, EVALUATION .....	30
5.1	Serial Interface and <b>BeamStream</b> Format.....	30
5.2	Switching Output.....	36
5.3	Analog Interface.....	37
6.	MULTI-DIRECTION OPERATION .....	38
6.1	Problem definition .....	38
6.2	Sequencing signals .....	39
6.3	Commissioning a multi-direction measuring system.....	40
7.	TECHNICAL DATA .....	41
7.1	Dimensions .....	41
7.2	Dimensions modular.....	42
7.3	Standard types .....	43
7.4	Technical Data .....	44

# 1. DESCRIPTION

## 1.1 Working Principle

The **InfraScan**®4000/10 series photoelectric light curtains are electronic precision measurement instruments, which operate on the basis of infrared light beams. Each measuring system comprises two casings, one containing the emitters the other the receivers together with the electronics for light pulse and data output control.

### 1.1.1 Parallel Scanning

Together with the facing receivers, the infrared LEDs, which are lined up next to one another inside the emitter unit, form a grid of absolutely parallel beams. This principle permits the recognition and measurement of all objects, which attenuate infrared light or are impervious to it. The surface of the object or the distance between the emitter and receiver has no effect on the measurement.

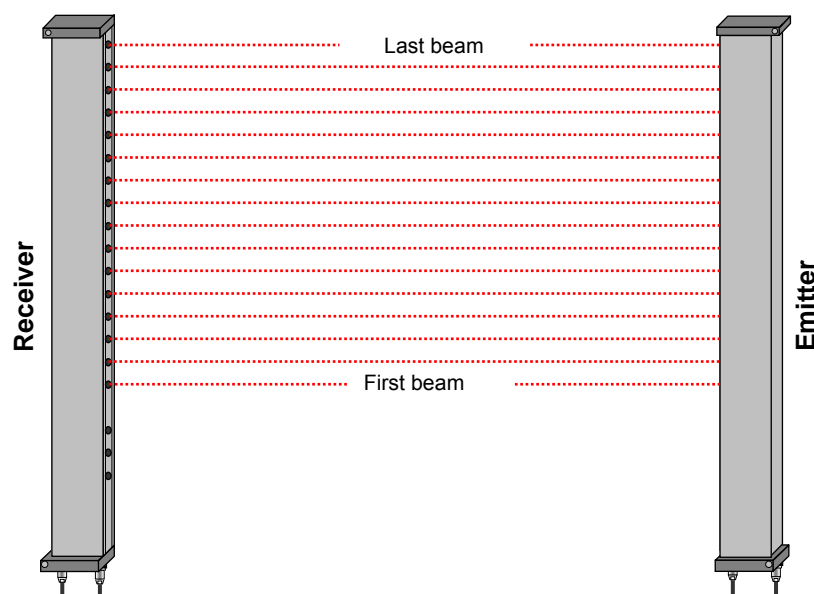

To perform the measurement, the individual infrared LEDs are activated in succession and the associated receivers are scanned at the same time. In other words, light beam "1" is interrupted at the moment the imaginary line from emitter "1" to receiver "1" is interrupted, since only the first receiver is scanned at the moment the first light beam is transmitted. This also applies accordingly to the following beams, resulting in the formation of a "light grid" comprising invisible light beams arranged in parallel to one another.

As only the associated receiver of each infrared LED is activated, wide-angle radiation is possible. The conical light beams ensure fault-free operation of the **InfraScan**® photoelectric barriers, even if they are exposed to severe vibration, which greatly simplifies adjustment when mounted.

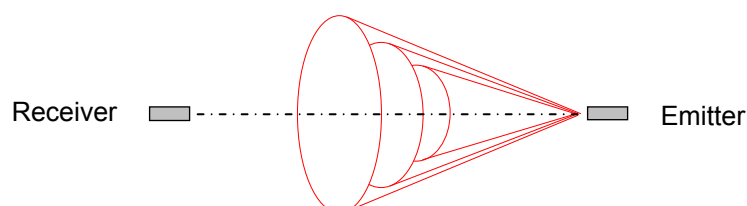

Depending on the version, between 12 and 288 beams with a resolution of 10 or 20 mm with parallel scanning are available. This is equivalent to a measuring range (= distance between first and last beam) of 110 – 2870 mm. With double scanning (see chapter 1.1.2) this corresponds to 23 ... 575 beams. A resolution of 5 mm<sup>1</sup> permits a measurement accuracy of ± 1.5 mm.<sup>2</sup>

In short, the measurement procedure can be described as follows:

Assuming that an object is located within the measuring range of the photoelectric barrier, the individual beams are activated in succession during a measurement cycle as described previously. The number of interrupted beams is indicative of the size of the test object.

The measured value is provided in the form of "DATA". In addition, the number of the first interrupted beam - and hence the position of the test object - can be output as the "POSITION" parameter. Since the individual light beams are parallel to one another, it is of no relevance to the measurement result whether the object is closer to the emitter or the receiver.

In the DoubleScan mode the enhanced resolution is only available in the centre between emitter and receiver.

The system's high clock rate (100 kHz), permitting up to 1200 measurements per second, ensures high measurement accuracy. This is all the more important the quicker the target object is moved through the photoelectric barrier and the more variable its shape is.

The evaluating logics of the receiver unit includes several arithmetic functions, with the aid of which the measured data can be pre-processed in real time<sup>3</sup>.

All these functions and data processing as well as data output via standard interfaces are incorporated. **No external units** are required.

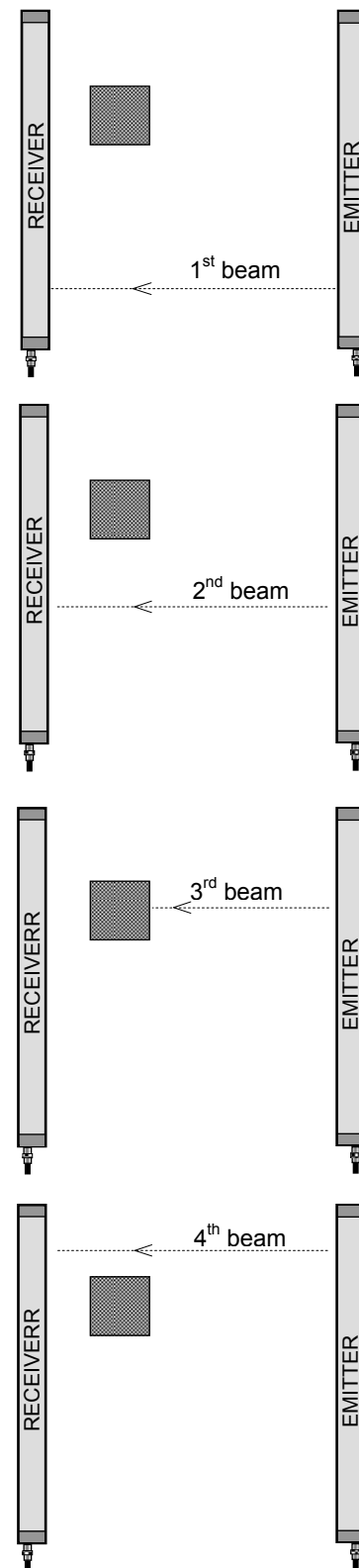

<sup>1</sup> 10 mm version in DoubleScanning mode in the center of measuring distance.

<sup>2</sup> Arithmetic mean calculated over 10 measurements.

<sup>3</sup> A (non)-received beam is evaluated within the time frame for the corresponding measuring beam. The clock rate of 100 kHz – corresponding to 10 µs per beam - is maintained irrespective of the selected arithmetic function.

### 1.1.2 Double Scanning (enhanced resolution)

For some applications a higher measuring accuracy or improved capability to detect very small objects may be desirable. For this purpose the function „Double Scanning“ or „enhanced resolution“ is available. The method used is to insert an additional beam, as it were, diagonally between the parallel beams.

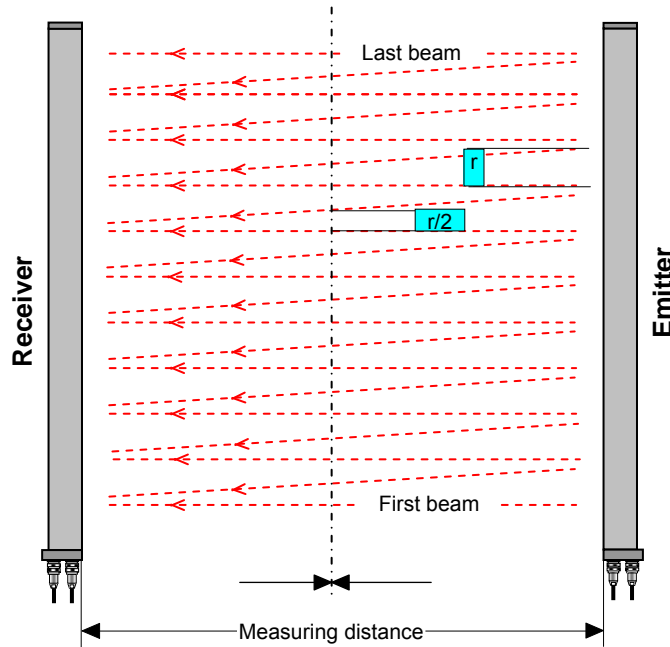

The first beam runs, as with parallel scanning, from emitter „1“ to receiver „1“, the second beam, however, from emitter „2“ to receiver „1“, the third beam from emitter „2“ to receiver „2“ (i.e. is parallel again), and so forth. If we call  $n_p$  the number of beams for parallel scanning, then the number of beams  $n_d$  for double scanning can be calculated by means of the formula  $n_d = 2 n_p - 1$ , i.e. 288 beams would result in 575 beams with a resolution of 1,25 mm (as against 2,50 mm for parallel scanning).

It should be noted, however, that this doubled resolution, as well as the corresponding smallest detectable object size, only applies to the **centre of the measuring distance (between emitter and receiver)**.

By means of the **ScanView** software one can choose between parallel and double scan mode. The appropriate button on the menu is „**Specials**  **Double Scan**“. Click on the checkbox to activate or de-activate the DoubleScan function.

The light curtains series **InfraScan**®4000/10 are basically intended to serve as measuring devices. However, in special cases they are used for detection of objects. In such a case it should be noted that, although certain defects, e.g. broken cables or defects occurring in electronic devices, will lead to an output signal, these light curtains are not "self protecting".



**Please note that these light curtains are not designed for safety applications!**

## 1.2 System Description and Definitions

Looking at the measuring system as shown below, emitter and receiver vertical and connectors at the bottom, then the **bottom** beam is designated the **first** measuring beam and the **top** beam as the **last** measuring beam, according to the sequence of scanning.

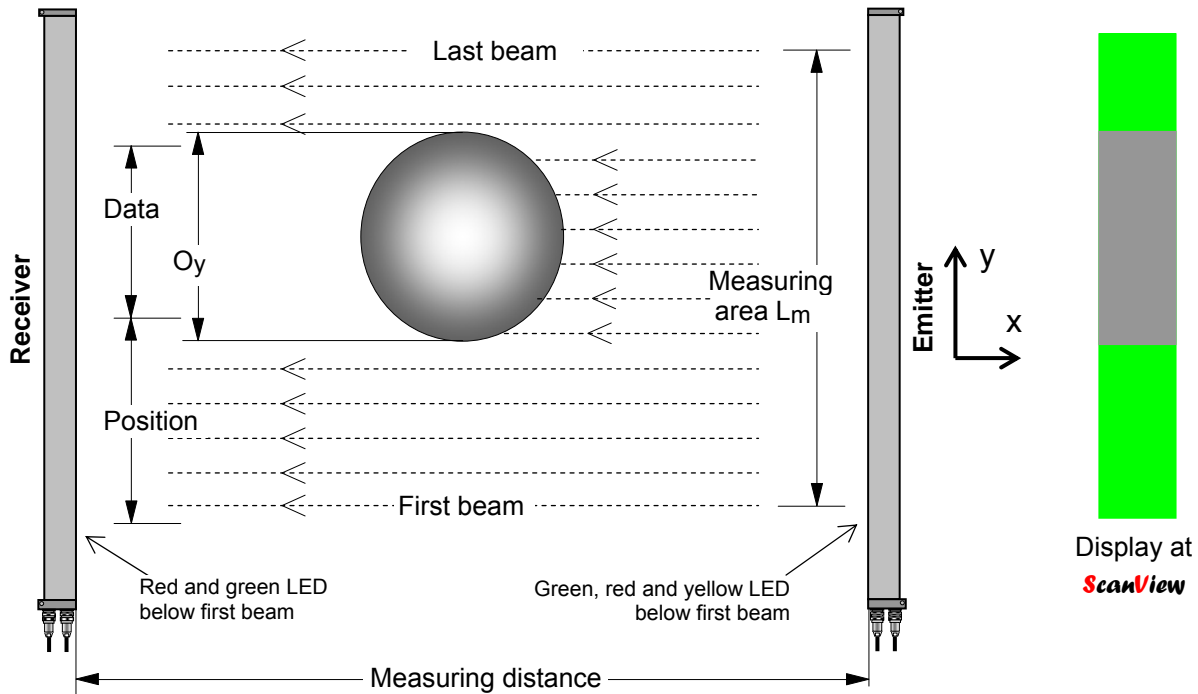

In addition, the optically active area is designated the **measuring area**, the number of interrupted beams is output as **DATA**. Alternatively, if preferred, the number of the first interrupted beam can be output and is designated as **POSITION**. By definition, the first beam is situated at the end nearer to the connecting sockets. The distance between emitter and receiver is designated the **measuring distance**.

The object size is named  $O_y$  and the difference to DATA is the measuring deviation. It must be distinguished between the maximum possible deviation for a single measurement and the average deviation over a number of measurements.

All units have the emitter equipped with a green, red and yellow LED. Units with serial output have the receiver equipped with a red and a green LED. These LEDs serve as indicators for proper alignment or for various defects. A detailed description of the functions can be found in chapter 3. "Mounting and Commissioning".

The measuring data can be "pre-processed". In addition to the "Normal"-mode described previously (DATA is the **sum of all broken beams**, independent of their "distribution" within the measuring area) the mode "**Largest Blocked Area**". It outputs the **largest continuously darkened area** as DATA and the number of the LED at which this area begins as "POSITION".

The mode „**Over All**“, on the other hand, outputs DATA as the area **as the very first to the very last broken beam**, disregarding possible "free" areas in between.

The "Smoothing" function can be used to define a minimum number of interrupted beams from which an interrupted area is evaluated. As a result, separate soiled areas remain suppressed without any noticeable effect on measurement accuracy.

The Smoothing value also determines, at which number of broken beams the **Switching Output** operates. The switching output is a standard feature with these scanners. When SOOTHING “1” is programmed, the output switches when (minimum) one beam is broken.

The standard method of delivering data is effected via a serial interface RS422. This interface permits bi-directional data traffic, thus offering the option of adapting the various parameters of the scanner even during operation.

Optionally (and additionally to the serial interface) the scanners can be equipped with an analog output. This is programmable for output of voltage or current and DATA or POSITION.

Data via the serial output can be provided in BINARY, GRAY or BCD code, either as number of beams or in mm.

The information “1<sup>st</sup> LED” and “last LED”, corresponding to “first beam broken” and “last beam broken”, are provided with the serial output only. Further features as, e.g. “Active Scan Area” or “Valid Data Value” add to the possibilities.

A more detailed description of all these functions and their programming you will find in chapter “4. Firmware Options”. By means of the **ScanView** software and an interface cable, which allows communication with the serial or USB interface of a PC, makes the configuration of the scanner very easy.

## 1.3 Maintenance

The **InfraScan**®4000/10 light curtains require practically no maintenance. Occasionally, particularly if one or more beams are dark because of soiled windows (which will be indicated by a flashing green LED on the receiver), just wipe the window surface with a soft cloth, if necessary use warm water or a mild detergent. Avoid scratching tools, hot water or steam.

## 1.4 Scope of Supply

An **InfraScan**®4000 measuring system comprises the following components:

1. Emitter with ports for synchronization and power supply,
2. Receiver with ports for synchronization, serial data output and switching or analog output,
3. Synchronization cable (connecting emitter and receiver).
4. Supply cable,

**Optionally** can be ordered:

5. Data cable for the RS422 serial interface (or optionally an interface cable<sup>4</sup>) or an analog data cable in case the scanner was ordered with an analog interface respectively.
6. Interface cable **InfraScan**®4000/10 - RS422/RS232 or RS422-USB-2, if “after-delivery” programming of the scanner is intended. Description see chapter “5.1.6 The **ScanView** Software”.

---

<sup>4</sup> The version with USB converter is only available with 5 m length. With RS232 converter this cable is available in any length.

## 2. PRODUCT SELECTION

Depending on the application different demands on the scanner will be in the foreground. In most cases these will be the decisive criteria:

1. **Measuring range:** Will be determined by the variation in size and position of the measuring object. Standard units and their measuring ranges are listed in the following tables.

2. **Resolution:** The series INFRASCAN®5000 offers three different beam spacing, namely 10, 5 and 2,5 mm at parallel scanning and. 5, 2,5 and 1,25 mm respectively at double scanning.

Directly connected to the resolution is the **maximum measuring deviation** for a single measurement. This value will be cut to half when the measured object always moves on the same level (e.g. on a conveyor belt).

For continuous measuring usually the **average measuring accuracy** is of interest. The following tables show the arithmetic mean calculated over 10 measurements in the case the object moves freely up and down within the measuring range (in the y-direction). A typical case would be measuring logs in the sawmill industry.

### 2.1 Measuring accuracy and cycle time parallel scanning

The following table is an excerpt of the list of light curtains series **InfraScan®4000/10** which are available as standard.

Type	No. of beams	Resolution r [mm]	Measuring range Lm [mm]	Deviation single mmt. max. [mm]*	Average. m. accuracy [mm]**	cycle time [ms]
4012/10	12	10.0	110	12.5		0.84
4016/10	16	10.0	150	12.5		0.84
4032/10	32	10.0	310	12.5		0.84
4048/10	48	10.0	470	12.5		0.84
4064/10	64	10.0	630	12.5		0.84
4080/10	80	10.0	790	12.5		0.95
4096/10	96	10.0	950	12.5		1.11
4112/10	112	10.0	1110	12.5		1.27
4128/10	128	10.0	1270	12.5		1.43
4160/10	160	10.0	1590	12.5		1.75
4188/10	188	10.0	1870	12.5		2.03
4192/10	192	10.0	1910	12.5		2.07
4204/10	204	10.0	2030	12.5		2.19

\* Measuring range "free" on both ends of object. In case POSITION is output or scanner is used for "height" measurement, half of this value applies.

\*\* Arithmetic mean of 10 measurements.



## 2.2 Measuring accuracy and cycle time double scanning

The following table is an excerpt of the list of light curtains series **InfraScan**®4000/10 with DoubleScan<sup>5</sup> which are available as standard.

Type	No. of beams	Resolution r [mm]	Measuring range L <sub>m</sub> [mm]	Deviation single mmt. max. [mm]*	Average m. accuracy [mm]***	Cycle time [ms]
4012/10	23	5.00**	110	7.5**	± 1.5***	0.84
4016/10	31	5.00**	150	7.5**	± 1.5***	0.84
4032/10	63	5.00**	310	7.5**	± 1.5***	0.84
4048/10	95	5.00**	470	7.5**	± 1.5***	1.15
4064/10	127	5.00**	630	7.5**	± 1.5***	1.47
4080/10	159	5.00**	790	7.5**	± 1.5***	1.79
4096/10	191	5.00**	950	7.5**	± 1.5***	2.11
4112/10	112	5.00**	1110	7.5**	± 1.5***	2.05
4128/10	128	5.00**	1270	7.5**	± 1.5***	2.3
4160/10	160	5.00**	1590	7.5**	± 1.5***	2.8
4188/10	188	5.00**	1870	7.5**	± 1.5***	3.0
4192/10	192	5.00**	1910	7.5**	± 1.5***	3.1
4204/10	204	5.00**	2030	7.5**	± 1.5***	3.3

\* Measuring range "free" on both ends of object. In case POSITION is output or scanner is used for "height" measurement, half of this value applies.

\*\* In the centre of the measuring distance.

\*\*\* Arithmetic mean of 10 measurements.

## 2.3 Distance Ranges (Variable Gain)

Due to the fact that the measuring scanners are used at differing measuring distances, the various signal strengths have to be adapted accordingly in order to ensure correct operation of the receiver amplifier.

This can be achieved by specifying the measuring distance when ordering the scanner or by adapting gain to operating requirements via the serial interface, aided by the **ScanView** software, as described in chapter "4. Software Options".

32 possible gain settings are available, from 0.2 m ... 4.0 m. resulting from the combination of 4 emitter and 8 receiver settings.

Under no circumstances should the actual measuring distance (at which the scanners are mounted) be smaller than the set measuring distance, in order to avoid "over modulation" (see also chapter "3.5 Hints for Use Regarding Mounting").

A table showing the dependence between emitter and receiver settings, can be found in chapter "4.1 Programming measuring distance".

<sup>5</sup> DoubleScan is a firmware option. The order no. therefore does not change.

## 2.4 Ordering Code

### 2.4.1 Emitter and Receiver with Accessories

#### InfraScan

#### 4096/10.0-S

Emitter and receiver of series **InfraScan** 4000/10.0

No. of beams (parallel scanning)

10.0 resolution **10 mm**

20.0 resolution **20 mm**

(parallel scanning)

**S** Serial interface *and* Transistor switching output

**A** Serial interface *and* Analog output

**K...** customer specific no.

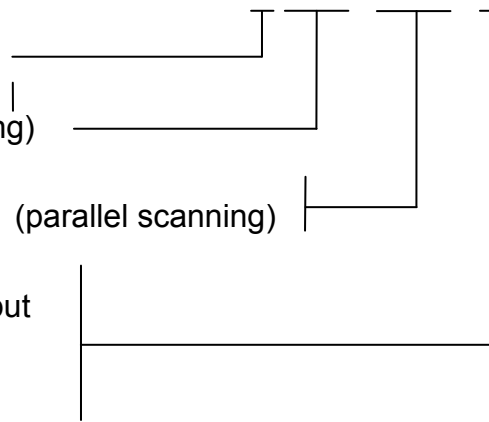

These details are only related to the scanner *hardware*. Please check with the following table, whether the standard scope of supply meets your requirements. All other parameters can be adapted by means of the **ScanView** software (see chapter “4. Software options”) or can be specified in the list below. The settings will then be done in the factory.

Accessories	Standard supply	Options <sup>6</sup>
Synchronization cable	Length 5 m	<input type="checkbox"/> 8m <input type="checkbox"/> .....m <sup>7</sup>
Supply cable	See chapter 2.4.2	See chapter 2.4.2
Software Options	Standard settings	Options
Scanning method	Parallel scanning	<input type="checkbox"/> Double scanning
Measuring distance	Ca. 0,6 - 1 m	<input type="checkbox"/> ..... m
Data format	Normal	<input type="checkbox"/> Largest Blocked Area <input type="checkbox"/> Over All
Coding	BINARY	<input type="checkbox"/> GRAY <input type="checkbox"/> BCD
Output mode	Number of beams	<input type="checkbox"/> mm
Smoothing	1	<input type="checkbox"/> .....
Active scan area	First and Last LED Offset: 0	<input type="checkbox"/> First LED Offset ..... <input type="checkbox"/> Last LED Offset .....
Valid data value	Low: 0      High: 65535	<input type="checkbox"/> Low: ..... <input type="checkbox"/> High: .....
Software options for optional interfaces		
<b>Analog output</b>	0-10 V	<input type="checkbox"/> 4-20 mA <input type="checkbox"/> 0-20 mA <input type="checkbox"/> 0-24 mA
Output of:	DATA	<input type="checkbox"/> POSITION
Switching output	Low active	<input type="checkbox"/> High active

### 2.4.2 Cables and Connectors

#### Synchronization cable

#### SK40-6/... m

Synchronization cable, shielded

Required length in m

Standard length is 5 m



<sup>6</sup> Please tick where applicable.

<sup>7</sup> For cables longer than 5 m a surcharge is applicable.

**Supply cable**

**Supply cable**, shielded, for Power supply and sequencing

Standard lengths are 2m or 5m

**AK40-6/... m**



**Data cable, analog**

**Data cable**, shielded, for analog data output

Standard lengths are 2 m or 5 m

**DK40-3/... m**



**Data cable, switching output**

**Data cable**, shielded, for switching output

Standard lengths are 2 m or 5 m

**DK40-2/... m**



**Data cable, serial**

**Data cable**, shielded for serial data output RS422

Standard lengths are 2 m or 5 m

**DK40-6/... m**



**Interface cable**

**Data cable** (for serial data output) with connector 7 pins and plug housing 9 pins Sub-D for PC-connection inclusive converter RS422 ⇒ RS232.

Standard length is 5 m

**IK40-6/ 5 m**

**IK40-5/5m<sup>8</sup>**  
USB Converter

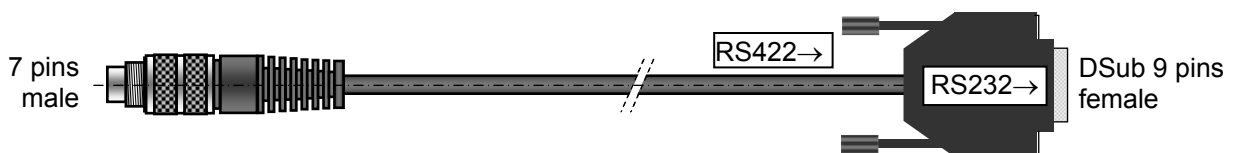

This interface cable also serves for programming the scanner by means of the **ScanView** software. For detailed description see chapter „5.1 Serial Interface“.

<sup>8</sup> The interface cable IK40-5/5m with USB converter is only available with 5 m length

### 3. MOUNTING and COMMISSIONING

#### 3.1 Mechanical Preparations

The dimensions of the casings, required to prepare for the mounting, are shown under technical data (chapter 7.1).

Emitter and receiver should be mounted parallel to each other and at the same height in order to achieve the optimum in functioning particularly, however, to ensure the best alignment of the optical axis of the beams. Thereby the vertical position is of the utmost importance as a shift would lead to a vertical misalignment by the value  $v$ .

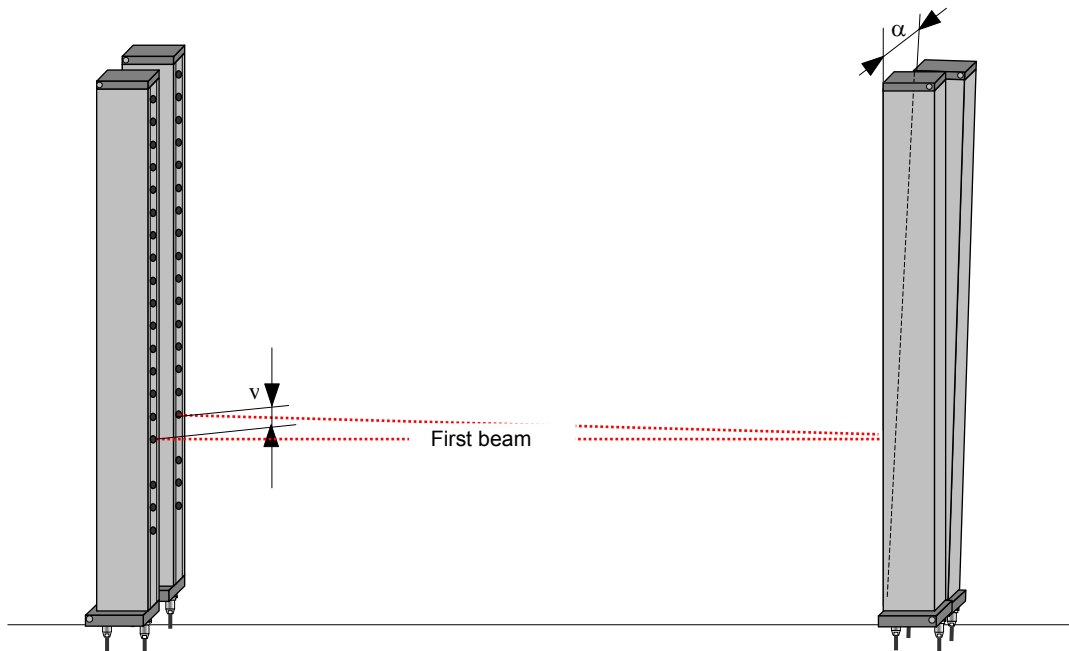

An inclination of the angle  $\alpha$  or  $\beta$  has hardly influence on the optical axis, however, a twist (particularly of the emitter) by the angle  $\alpha$  or  $\omega$  can reduce the measuring distance, which cannot always be compensated (see also chapter 2.3).

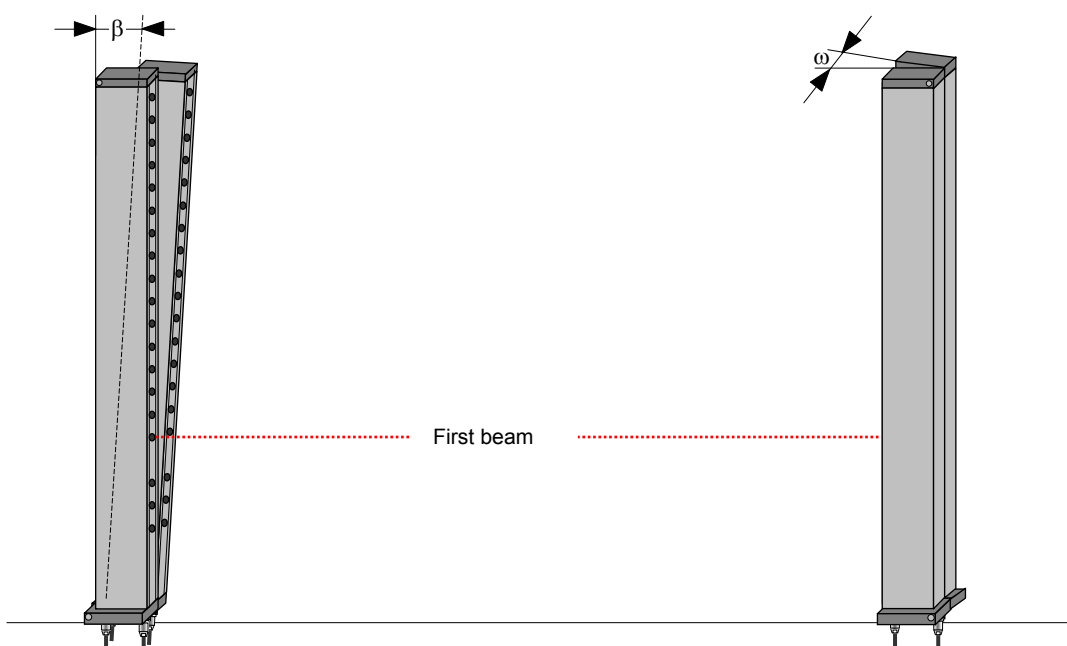

Then make the electrical connections according to the following description.

### 3.2 Electrical Connection

The measuring system can be connected in just a few operations:

1. Connect emitter and receiver by means of the provided synchronization cable. The appropriate socket on the emitter is marked SYNC.

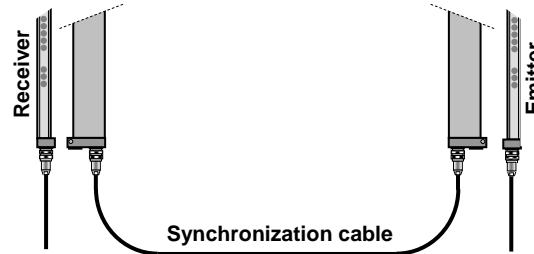

2. Connect **24V power supply** on the **emitter**.

If more than one scanner is in use, which need to be sequenced, please note the connector wiring described in chapter 6.2.

Signal	Cable*
+24 V	pink
GND	grey

\*Leads not in use must be insulated in order not to make contact with neither +24 V nor GND.

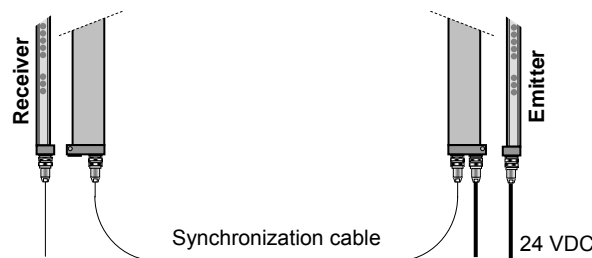

3. Connect **data cable** to the corresponding connector of the **receiver**.

Wiring of the connectors, depending on the type of interface, is described in the appropriate chapter (either 5.1, 5.2 or 5.3).

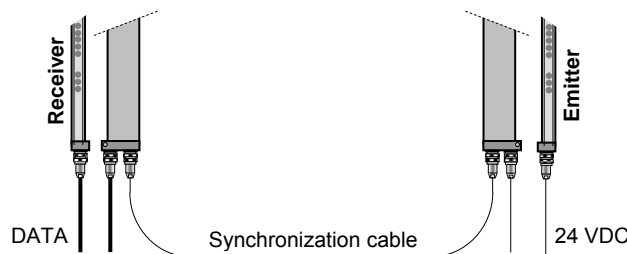

4. Switch on voltage supply. The **green LED** on the **emitter** should be "on" now.



**Attention: Never connect or disconnect synchronization cable or data cable when power is ON!**

To allow checking the basic functions regarding electrical connection, there are LEDs located at the emitter and receiver, providing the following indications.

Receiver (without LED display)	
Red LED is on	Communication problem with emitter
Red LED flashes	Error message from DA converter (e.g. no load at output)

Emitter	
Green LED is on	Voltage supply is o.k.
Green LED flashes	Voltage supply $\leq$ ca. 19.5 VDC
Red LED flashes once	Communication problem with receiver
Red LED flashes twice	Initialization error
Yellow LED is on	Sequencing is o.k.

### 3.3 Adjusting

First of all make sure there is **no object within the measuring range**. Receivers with a **serial interface** are equipped with a red LED, just underneath the first infrared LED. This LED serves as adjusting aid and provides the following indications:

Receivers without LED display	
Green LED	Information
is on	All beams "free", scanner is well adjusted
flashes	At least 1 beam has a bad signal, alignment not is at optimum or programmed measuring distance exceeded
is dark	At least 1 beam is completely interrupted

In order to detect even a single beam missing or with a bad signal, it is necessary to set the **Smoothing** value to 1 when checking the correct adjustment. However, independently of the programmed value, Smoothing will be set to 1 automatically for approximately 60 seconds after switching on power. After this period Smoothing will be set back to the originally programmed value.

In case no proper functioning of the scanner can be obtained it is either necessary to reduce the measuring distance or – if this is not possible – to adjust emitter or the receiver settings to a larger measuring distance. This is easily done via the serial interface by means of the **ScanView** software.

The serial output can be used as such (permanently) or only for configuration (by means of the **ScanView** software) or for visualization of measuring data respectively of the scanner.

### 3.4 How to Earth the System

#### 3.4.1 General

To comply with the standards for electro magnetic compatibility, the measuring system **InfraScan®4000/10** in its structure, electronic circuitry, connectors and casing was designed in such a way as to achieve the highest standards in this respect. However, to make use and to maintain this standard, the system must be installed according to the rules outlined in this chapter.

Both transmitter and receiver electronics are mounted into hermetically sealed aluminum casings. The scanner electronics is connected to the metal casing via filters. Therefore no connection exists to signal ground (GND) when the metal casing is connected to protection earth (PE). The aluminum casing is connected with the shield of the data and supply cable. ***These shields need to be earthed in the switch board.***

#### 3.4.2 Shields of Supply and Data Cable

To ensure that high frequency currents which are induced into the cable are shunt to earth safely even with single sided shielding, the connection from shield to protection earth should have a low inductivity. The previously mentioned measures for optimizing inductivity should be applied just as carefully. Make sure the connection to earth is of **low inductivity**.

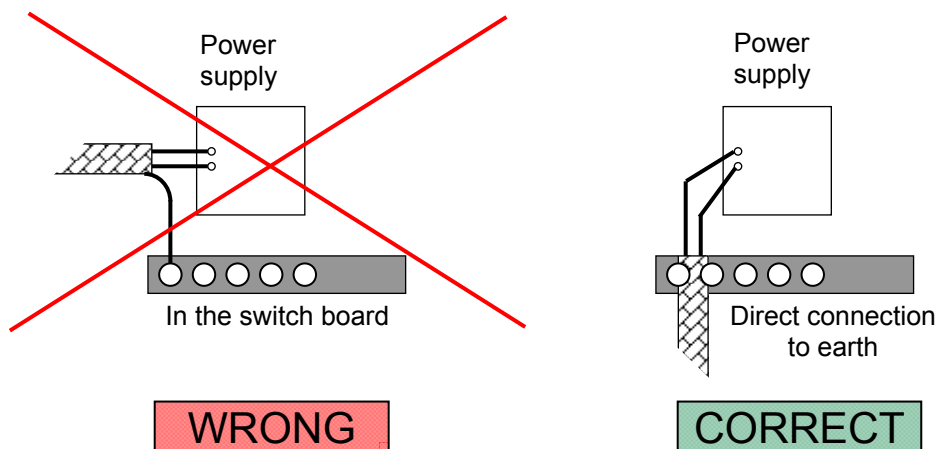

**The connection of shield and earth has to be made in the switchboard.**

### 3.5 Hints Regarding Mounting

Certain ambient conditions or circumstances can influence the light curtain. By taking suitable measures on site problems can be avoided. In the following points some guidelines should be provided.

#### 3.5.1 Reflections

Due to the wide-angle radiation of the infrared emitters - with the advantages described before, like ease of adjustment and immunity against vibration - problems may occur with reflections. E.g. it could happen that not only the direct light of the infrared beam is picked up by the receiver, but also a reflection of it. Particularly this can happen when a reflecting surface is situated near to the measuring system.

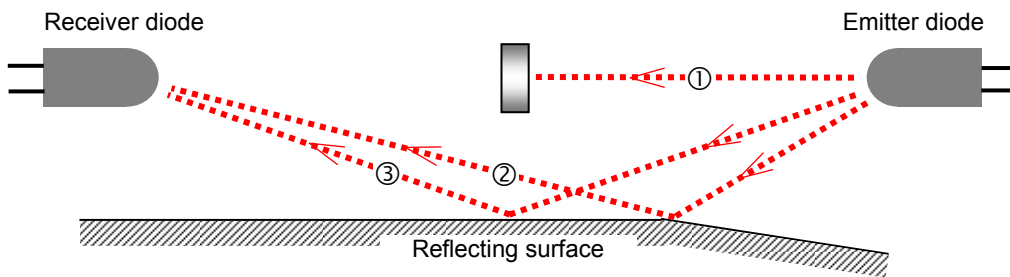

An object would interrupt the direct light of a beam (①). However, if its reflection - via a shiny surface - reaches the corresponding receiver, the beam would not be detected as "dark" (beam ② or ③). These beams or adjacent ones respectively, would not be registered. The output value is **too small or the object will not be detected at all**.

The farther away the reflecting surface is from the beams level the wider is the angle of reflection and the less is the danger of an influence by reflections.

**Be aware of shiny or highly reflective surfaces near to the scanner, which could lead to reflections onto the receiver.**

In case it is not possible to move the scanner farther away from the reflecting surface other measures have to be taken to avoid reflections to reach the receiver, as in the following examples. Occasionally conveyor belts or similar transport devices are causing reflections.

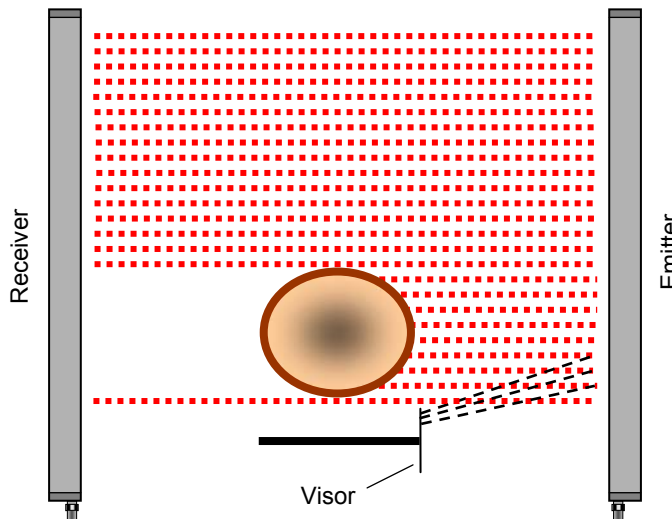



In such cases visors are the solution which should be mounted as near as possible to the reflecting surface. These guard plates shield off the reflecting beams, particularly the bottom beams. The reflections of the top beams are not critical because the signals reaching the receiver are very weak.

Another possibility to avoid reflections is to mount emitter and receiver "asymmetrically", whereby it is better to have the emitter farther away.

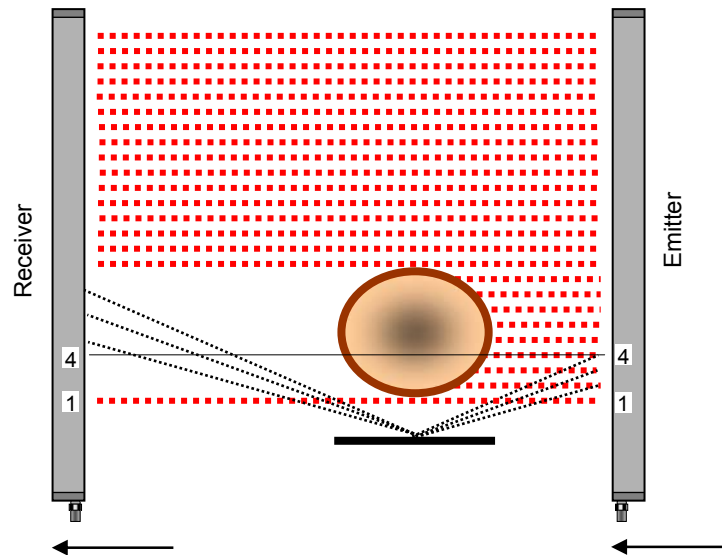

The latter method makes use of the fact that at any time only one emitter and the corresponding receiver is activated. The reflection of a beam would have to aim at exactly the corresponding receiver to influence the measuring. The "asymmetrical" positioning of the scanner in respect to the reflecting surface suppresses this effect.

Reflection may also occur through shiny rollers or conveyor belt drums.

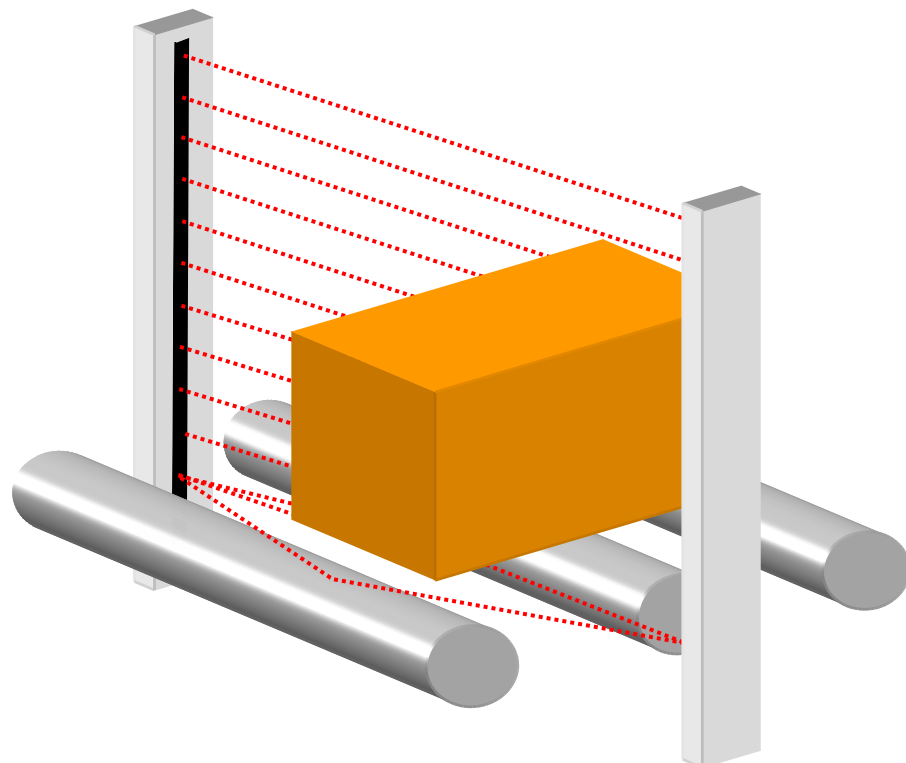

### 3.5.2 Influence of ambient light

Fundamentally the scanner system only accepts light **impulses**. The sensitivity for ambient light (e.g. sunlight) is greatly reduced by adequate electronic circuits, however, it cannot (and in fact should not) completely be eliminated.

The infrared receiver diodes are equipped with daylight filters. Light sources with a high content of infrared light (e.g. sunlight), however, can influence the receivers in such a way that the affected beams become interrupted. On the other hand is this an important function. Otherwise it could possibly happen that a real interruption is not detected.

**Make sure no intensive infrared light sources (particularly morning or evening sunlight) can shine directly or indirectly into the receiver.**

To overcome such a problem it is in most cases sufficient to change the position of emitter and receiver or to move the receiver out of the reflective zone. Again please observe to stay within the range (see chapter 2.3.).

Also other infrared beams can cause problems when they shine into the receivers of the INFRASCAN or when two INFRASCANs operate near to each other. In this case make sure that receivers and emitters are not mounted adjacent to one another.

**Do not mount emitters and receivers adjacent to one another in multiple installations!**

**Multi-direction (x-y-systems) operation is described in chapter 6.**

### 3.5.3 Over-modulation of receiver

To adapt the light curtains INFRASCAN®4000 to the distances they are used at the receivers are equipped with variable gain (see chapter 2.3).

As a matter of principle each gain factor corresponds to a certain measuring distance to guarantee the best functioning of the measuring system. Programming differing to these standards must be carried out with great care and the necessity to do so is in many cases an indication of a different problem. Increasing the gain value above the recommended setting leads to a higher signal, however, enhances the danger of over modulation, possibly leading to false readings.

**Adjust gain factor according to the recommended measuring distance!**

Programming a too high a gain factor additionally supports faulty measurement by reflected beams, as these are also higher amplified than they normally would be. This way beams may not be interrupted as they would be if the setting was correct.

**A too high a gain factor favours faulty measurements caused by reflections!**

## 4. FIRMWARE OPTIONS

### 4.1 Setting of measuring distance

#### 4.2.1 Scanners with Standard Firmware (Series A)

As described in chapter 2.3, 4 options for the emitter (emitter power, so to speak) and 8 options for the receiver gain are available, which can be combined in any way. This results in 32 different measuring ranges, which partly overlap.

When looking for the ideal combination, one should start from the lowest possible emitter setting, which allows attaining the required measuring distance. Should it be necessary to set the receiver amplification to 6 or 7, increase emitter power by one digit. An exception is of course the highest measuring range.

The following table is only a guideline. The ideal setting for the application has possibly to be checked by tests or can be pre-set in the factory as required.

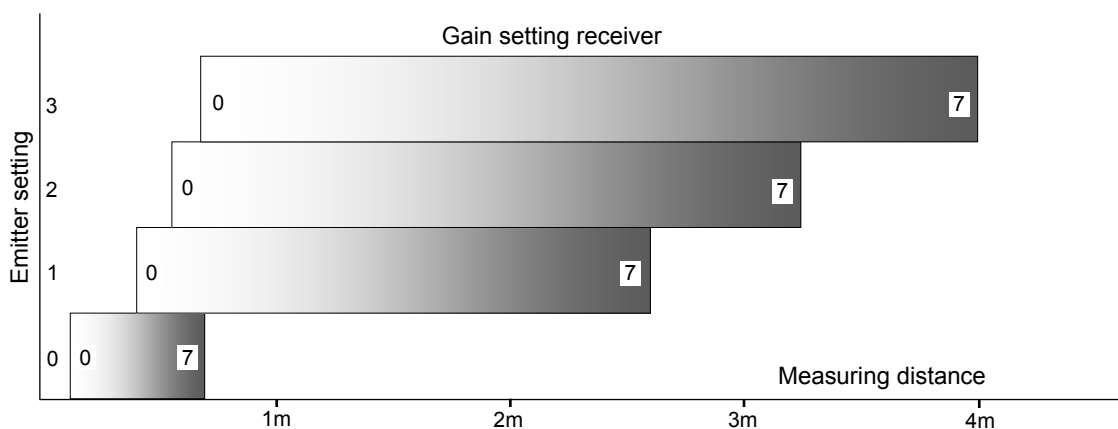

By means of the **ScanView** software the scanners can easily be programmed. The appropriate point in the menu is „Receiver [Gain 0-7]“ und „Emitter Gain [0-3]“. Just enter values into the box.

With button  the value is sent to the scanner, button  will memorize the setting.

#### 4.1.2 Scanners with DSE (Digital Signal Equalizer) (Series B)

As with series A, series B too offers 4 options for the emitter and 8 options on the receiver, which can be combined in any way. This again results in 32 different measuring ranges, which partly overlap

Moreover, with series B comes a „fine tuning“, which allows the detection or measuring of transparent or partly transparent objects respectively. This will be described in the following chapter.

For Series B little different guidelines are applicable as compared to those for Series A. The ideal setting for the given application has possibly to be verified by tests. It is also possible to order factory settings.

First select suitable combination of emitter and receiver gain for the required measuring distance in [m]. Please refer to the table below.

By means of the **ScanView** software the programming can be done very easily. The appropriate point in the menu is „Receiver [Gain 0-7]“ and „Emitter Gain [0-3]“. Just enter values into the box.

With button  the value is sent to the scanner, button  will memorize the setting.

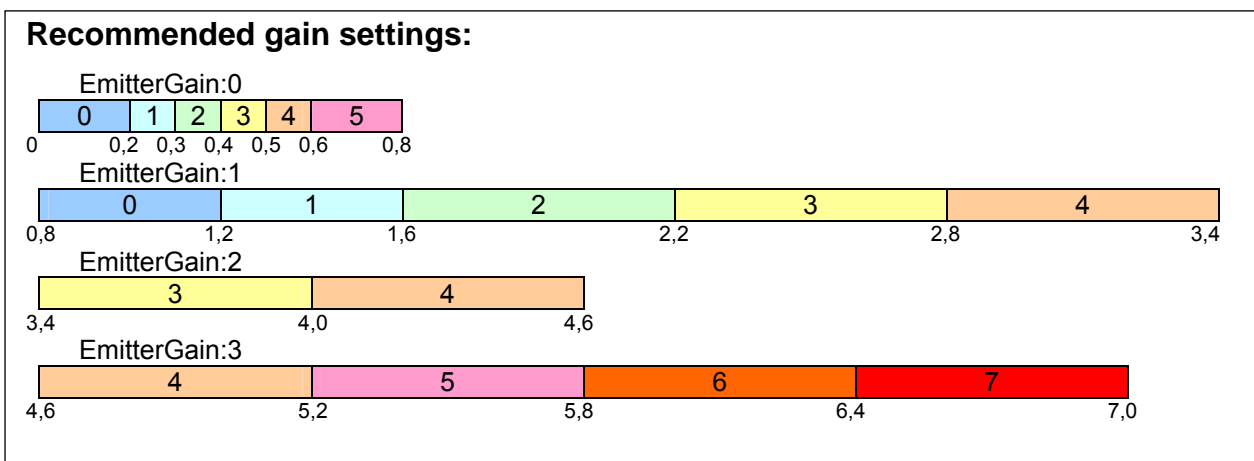

Then – again by means of the **ScanView** Software (version 1.9 or higher) - with **Options > Calibration > Gap** the "fine tuning" can be done:

Enter the required value for **Gap** in the window. With button  it needs to be sent to the scanner. Before continuing, make sure that all beams are „free“ and the window is not soiled in any way.

With button  the fine tuning with **InfraScan** will be executed (recognizable by a short flash of the red LED on the receiver).

With button  the setting will be saved.

The value for „Gap“ should be within 20..80. The higher the value, the more transparent the object can be. It should be born in mind, however, that the sensitivity regarding electro magnetic compatibility will increase.

 Button  will erase these data!

Before starting the fine tuning make sure the measuring area is unobstructed and either Parallel Scan or Double Scan is selected. If there is a change from Parallel Scan to Double Scan or vice versa, the fine tuning must be repeated!

## 4.2 Special Settings

### 4.2.1 Inverted mode

„Normally“, when measuring by means of the „through-beam-method“, the size of an object is determined by the number of **interrupted beams**.

In the case, however, that cut outs in an object should be measured (also in the case of detecting holes in an object), it is exactly contrary. Here the number of **not interrupted beams** determines the size (Ill. 2).

The same applies for reflecting (though even transparent) objects, as e.g. glass or plastic foils. In this case too the reflected (hence **not interrupted beams**) determines the size (Ill. 3).

The so-called „Inverted mode“ serves to „reverse“ the function. Other functions, (e.g. Output modes, Smoothing, Double scanning, etc.) remain active. However, setting of measuring distance may be different than in the „normal“ case.

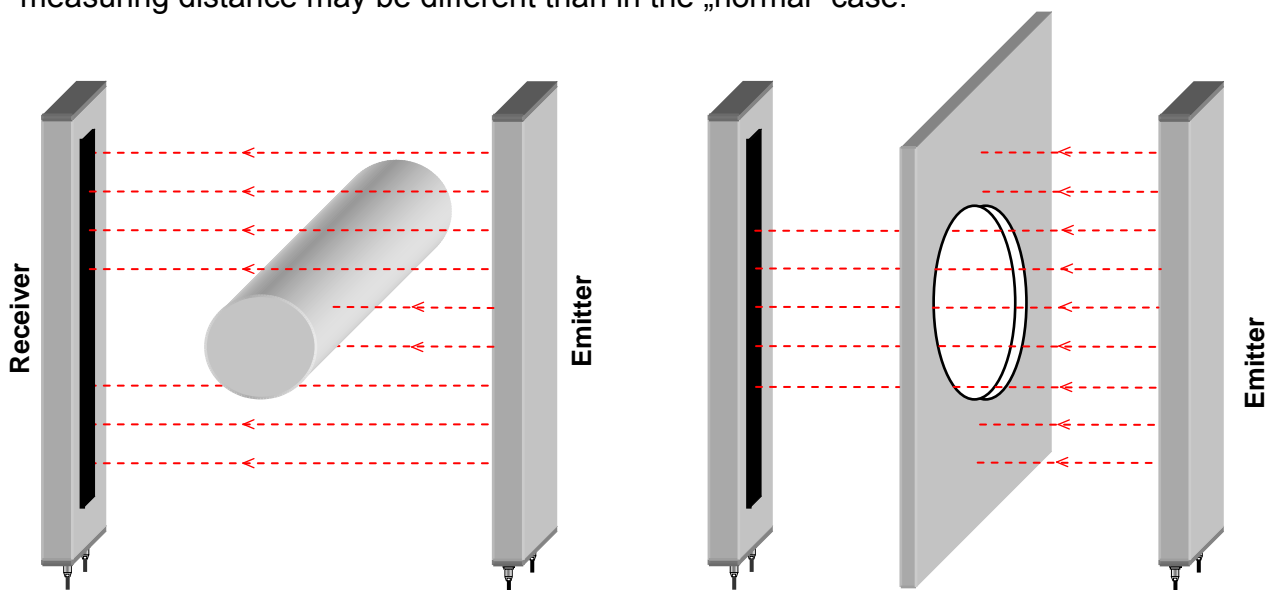

Illustration 1:  
Through-beam-principle  
The number of interrupted beams is being counted

Illustration 2:  
Through-beam-principle – „inverted“  
The number of **not interrupted** beams is being counted

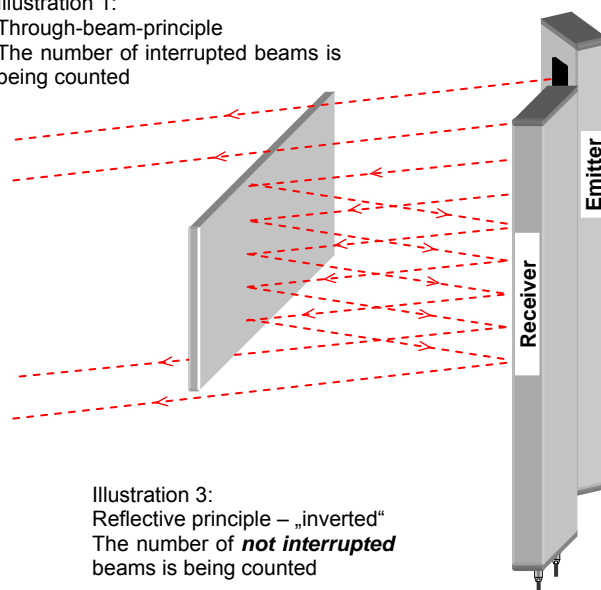

Illustration 3:  
Reflective principle – „inverted“  
The number of **not interrupted** beams is being counted

The **ScanView** software allows to select **“inverted mode”**. The appropriate menu point is **„Specials  Inverted Mode“**. To activate click on the Checkbox.

With button **Set Config** the value is sent to the scanner, button **Store Config** will memorize the setting.

### 4.2.2 Parallel-/Double Scanning

By means of the **ScanView** software it is possible to switch from parallel to double scanning (description see chapter „1.1 Working principle“).

Select „**Specials**  **Double Scan**“ in the main menu. Click on the checkbox to activate the double-scan function or to de-activate it.

With button **Set Config** the value is sent to the scanner,  
 button **Store Config** will memorize the setting.

The evaluation/output of DATA or POSITION respectively changes automatically.

### 4.3 Active Scan Area

This function allows specifying a **certain section** of the measuring area to be “active” and within which the actual measuring (or detecting) takes place. For this purpose the „first active diode“ and the „last active diode“ need to be defined. This can be done by means of the **ScanView** software via the serial interface.

In this connection we speak of LEDs rather than beams. One could also speak of the first and last **parallel** beam. Within this defined **active** area parallel or double scanning can be applied.

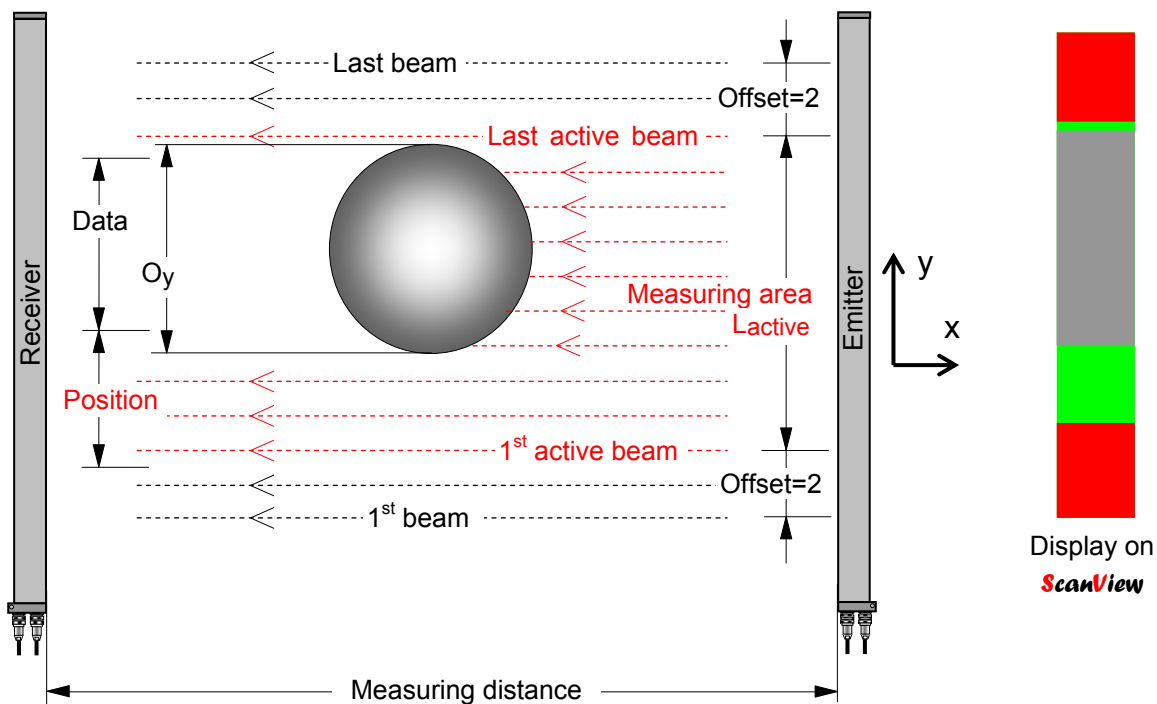

Programming is done by means of the **ScanView** software. The appropriate menu points are „**First LED Offset [0-254]**“ and „**Last LED Offset [0-254]**“. E.g.: „First LED Offset“ = 2 means that the active scanning area begins at the 3<sup>rd</sup> LED. „Last LED Offset“ = 2“ means that the active scanning area ends at the 3<sup>rd</sup> beam from „top“.

**POSITION** is now counted from the **first active beam**. Informations **FIRST\_LED** and **LAST\_LED** (1<sup>st</sup>. beam and last beam respectively dark), refer as well to the 1<sup>st</sup> and last **active** beam.

With button **Set Config** the value is sent to the scanner,  
 button **Store Config** will memorize the setting.

### 4.4 Valid Data (Threshold)

This function allows stipulating, which **minimum data value** in **number of beams** or up to which **maximum data value** data should be output at all.

**Threshold Low** means data output  $\geq$  the stipulated value, **Threshold High** means data output  $\leq$  the stipulated value.

This value is related to the actual output (DATA or POSITION), depending on the evaluation method used (possibly influenced by the output mode, as e.g. Largest Blocked Area mode or Smoothing).

Data values  $<$  **Threshold Low** and  $>$  **Threshold High** will be output as 0.

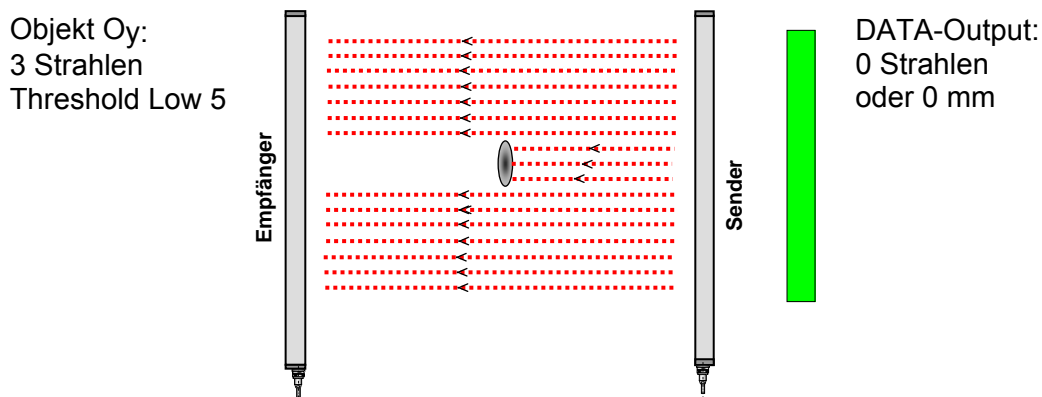

The Threshold value can be programmed by means of the **ScanView** Software. Simply enter the value under „**Threshold Low [0-65535]**“ or **Threshold High [0-65535]**“.

With button  the value is sent to the scanner, button  will memorize the setting.

The Threshold value is defined by the **number of beams**, even when the measurement is output in mm.

### 4.5 Smoothing

By means of the function Smoothing it is possible to "blank" a certain number of **adjacent** beams.

Smoothing „1“ means that any object of a minimum size<sup>9</sup> on will be measured or detected respectively.

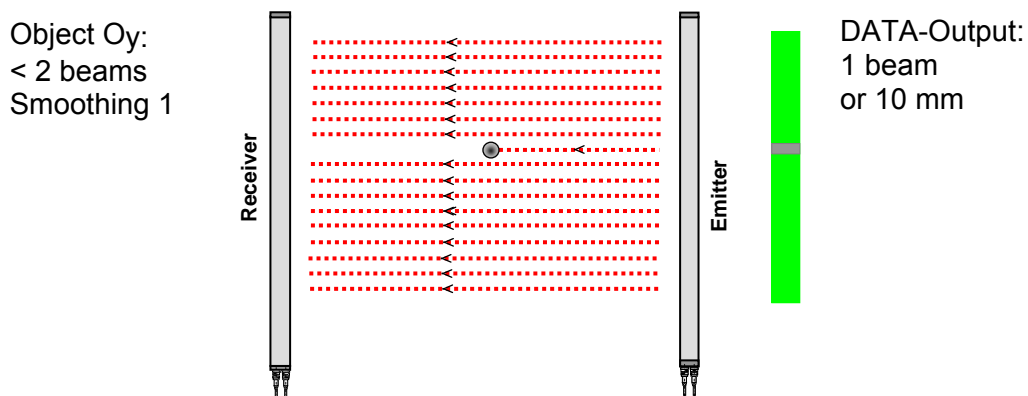

<sup>9</sup> See tables in chapter 2.1 and 2.2 "maximum deviation for single measurements."

If the Smoothing value in this example is set to Smoothing 2, the result "0 beams interrupted" is obtained. Other objects smaller than "beams" will not be measured either.

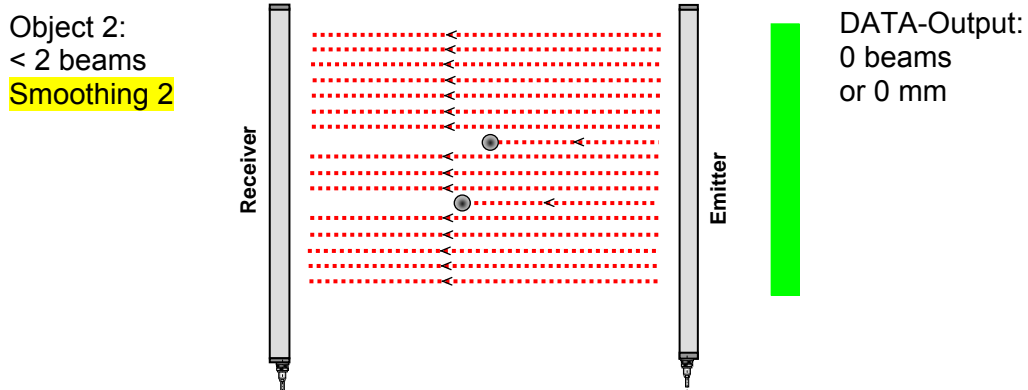

An object, however, above this **Smoothing value** will be output with the exact result.<sup>10</sup>

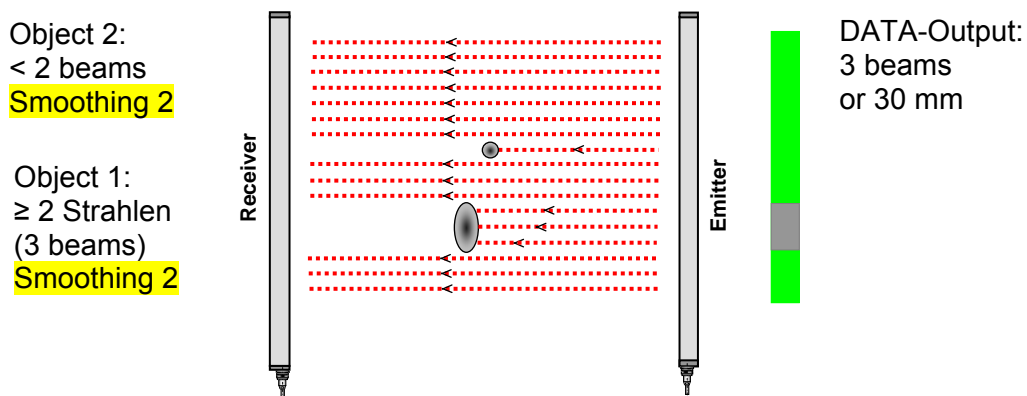

A possible application is, e.g. the "blinking" of soiled or defective parts of the measuring area<sup>11</sup>

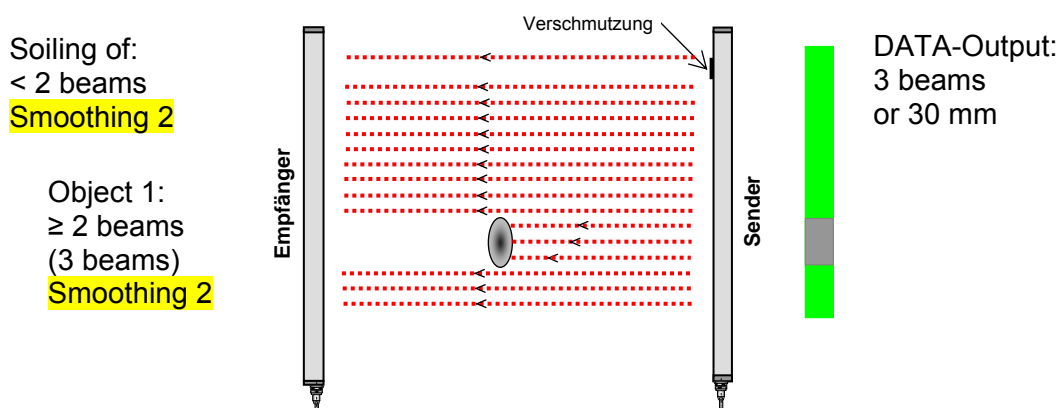

<sup>10</sup> As soon as two objects are recognized (at least one measuring beam is passing in between them), the scanner applies the Smoothing function to both objects separately.

<sup>11</sup> To detect whether soiling within the measuring area has occurred, it is only necessary to set the Smoothing value to 1. A new start of the system (switching OFF and ON of power) will have the same effect. Smoothing will then be set to 1 for about one minute.



In short, the **Smoothing** feature of the **InfraScan®4000/10** measuring system can be used to pre-define a threshold value between 1 and 255 by selecting a suitable Smoothing value. As a result, "broken beams" are **only evaluated as "interrupted"** if the number of **directly adjacent** interrupted measuring beams is greater than, or equal to, the Smoothing value.

Isolated LED failures therefore do not affect the measurement result. Only when a number of (**successive!**) beams is interrupted, which is pre-set by means of the Smoothing function, this is recognized as "valid" by the receiver.

By means of the **ScanView** software a suitable Smoothing value can be programmed very easily. In the main menu go to „**Smoothing [1-254]**“. Enter the required value into the Box.

With button  the value is sent to the scanner, button  will memorize the setting.

The Smoothing value is defined by the number of beams, independent whether Data output is in number of beams or mm.

## 4.6 Output Formats and Coding

The scanner can be programmed to provide several different data formats. Each format again can be coded in three different ways:

**BINARY                      BCD                      GRAY.**

The following output formats (modes) are available:

1. DATA/POSITION "**Normal**": The scanner outputs the number of interrupted beams as DATA and the position of the first interrupted beam as POSITION.
2. DATA/POSITION "**Over All**": In this mode, the beam counts the number of interrupted beams, but adds the number of uninterrupted beams within blocked areas to the value obtained and outputs the result as DATA. The number of beams from the **first to the last interrupted** beam is therefore added up. The number of the first interrupted beam is output as POSITION.
3. DATA/POSITION "**Largest Blocked Area**": The scanner outputs the largest continuously interrupted block as DATA and the number of the beam at which this block begins as POSITION.

### 4.6.1 DATA/POSITION - Normal

In this configuration, the number of interrupted beams is added up and the value is output as DATA. The start address of this block is output as POSITION.

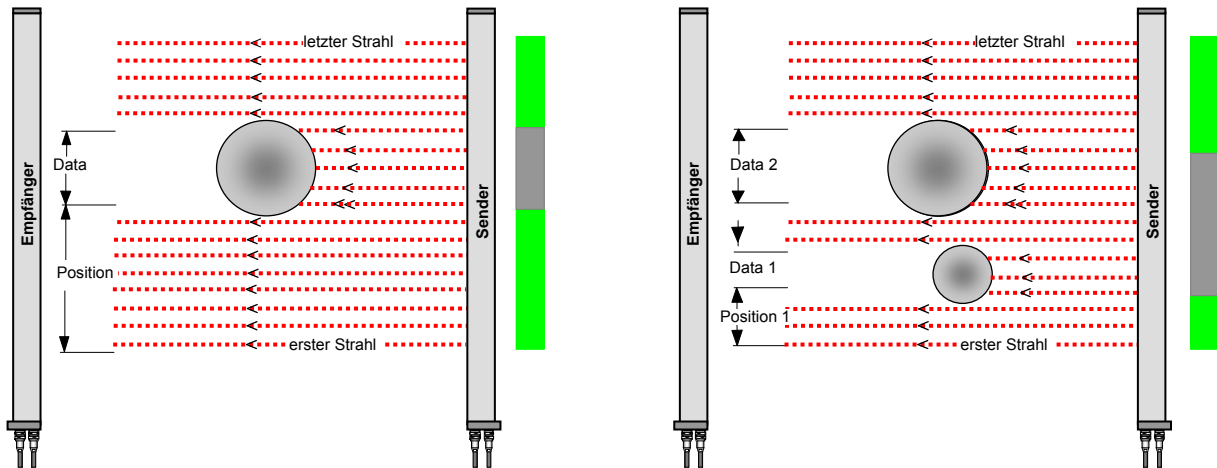

The left figure shows the *normal case* in which an object is located in the measuring range. The scanner determines the DATA and POSITION data of this object accordingly.

If two (or more) objects are located in the measuring range, then two (or more) DATA areas result. In this output mode, the data are evaluated as follows:

$$\text{DATA} = \sum \text{DATA}_n$$

$$\text{POSITION} = \text{POSITION}_1$$

By means of the **ScanView** software this format can be selected. Go to „Data Mode“ in the main menu, select from the list

**Normal Bin**

**Normal BCD**

**Normal Gray**

and confirm by mouse click. With button **Set Config** the setting will be sent to the scanner. Button **Store Config** will memorize the setting.

### 4.6.2 DATA/POSITION - Over All

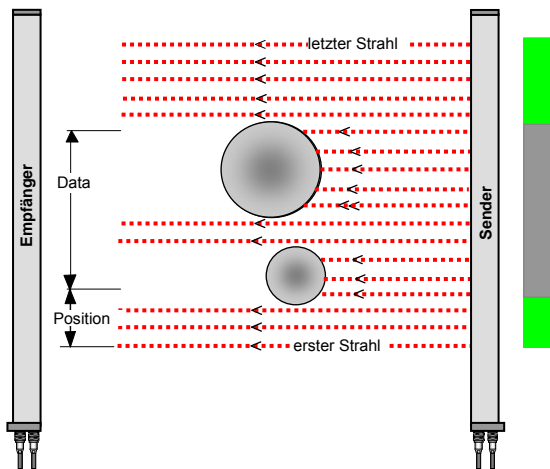

In this configuration, the number of beams between the **first and the last interrupted beam** is added up and the value is output as DATA. The start address of this block is output as POSITION.

If more than one objects are within the measuring area, the „space“ between the objects will be added to the DATA value.

By means of the **ScanView** software this format can be selected. Go to „Data Mode“ in the main menu, select from the list

**Over All Bin**

**Over All BCD**

**Over All Gray**

and confirm by mouse click. With Button **Set Config** the setting will be sent to the scanner. Button **Store Config** will memorize the setting.

### 4.6.3 DATA/POSITION - Largest Blocked Area

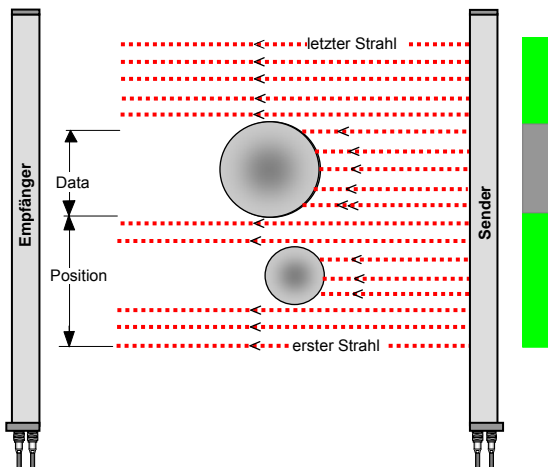

In this configuration, the **largest continuously interrupted block** is evaluated. The number of beams is output as DATA. The start address of this block is output as POSITION.

This means that from several objects within the measuring area only the largest of them will be detected and measured.

By means of the **ScanView** software this format can be selected. Go to „Data Mode“ in the main menu, select from the list

**Largest Block Bin**

**Largest Block BCD**

**Largest Block Gray**

and confirm by mouse click. With Button **Set Config** the setting will be sent to the scanner. Button **Store Config** will memorize the setting.

## 4.7 Output Mode Beams/mm

In any version DATA as well as POSITION can either be output as **Number of Beams** or in **mm**.

By means of the **ScanView** software one can easily switch between **Number of Beams** and **mm**. The appropriate sub menu is:

„Result Type  **Beam count**  **mm**“.

Clicking on the checkbox will activate the appropriate function.

With button **Set Config** the selection is sent to the scanner, button **Store Config** will memorize the setting.

The calculation/output of DATA and POSITION respectively changes automatically.

## 4.8 Remote Diagnosis (Error Messages)

By means of the **Get Error...** button on the **ScanView** main menu an error record can be called. The error messages remain in the record until this is deleted. To delete the error record, click on the **Reset Error** button (even when the error has been found and mended).

Error record data are volatile, which means that clicking on the **Reset** button or switching off the supply voltage also deletes the record.

The individual bits indicate the following error messages:

Bit 7	Bit 6	Bit 5	Bit 4	Bit 3	Bit 2	Bit 1	Bit 0
X	X	Defective analog output (available only from series „C“ onward): Cause: E.g. open current loop.	Number of beams non congruent with number of emitter beams. Cause: Emitter module defective or emitter does not match with receiver.	No communication with emitter. Cause: Sync- and supply cable mixed up or emitter is of an older generation.	Faulty communication between emitter and receiver. Cause: E.g. defective synchronization cable.		One or more weak receiver signal.

## 4.9 Original Configuration

By means of this function of the **ScanView** software it is possible to return to the original setting (factory settings), after having made alterations to one or more of the parameters. All the alterations made will be deleted.

To return to the original settings, click on the **Restore Defaults** button.

## 5. OUTPUTS, EVALUATION

### 5.1 Serial Interface and **BeamStream** Format

This interface allows for the connection between scanner and controllers with an RS422 port or – with the use of a so-called Interface cable - an RS232 port (e.g. PC interface ) or USB-2 port.

Signal	Cable*
RxD	White
/RxD	Brown
TxD	Green
/TxD	Yellow
+24 V	Pink
GND	Grey

The UART interface comprises two TxD and RxD signal lines.

#### Configuration of the Interface:

Baud rate [Bd]: 9600/19200/38400  
 Number of Data bits: 8  
 Number of stop bits: 1  
 Parity: even

The command set of the **InfraScan**®4000/10 measuring system is not only suitable for data transmission; it can also be used for configuring the receiver. It is worth emphasizing that simultaneous operation of the serial and analog interface is possible.

#### 5.1.1 Protocol and Timing of Serial Data Transmission

Communication is always initiated by the connected controller. At the same time, the first byte to be transmitted is always a command. If this command is recognized as "valid", it is confirmed by the receiver, which returns the same code (ECHO).

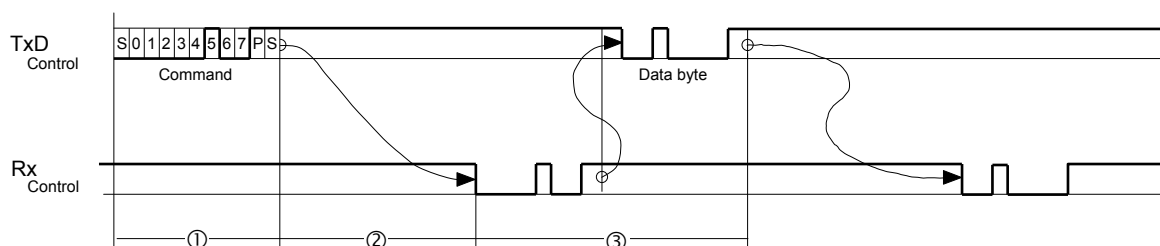

- ① Byte transfer time (at 38,4kBaud): 290 μs
- ② Delay: max..4500 μs<sup>12</sup>
- ③ Waiting time for subsequent data (command): max. 200 μs

In the write operation described above - **write\_gain** to receiver - the controller transmits the new gain value as a data value on arrival of the echo. The receiver checks its UART for the presence of the data value and confirms this with an additional echo 3 ms after transmission of the command echo has begun (!).

<sup>12</sup> For commands **write\_transmitter\_gain** and **write\_special** delay is up to 50 ms.

In the read operation shown below, **read\_gain** supplies the current gain value of the receiver: The controller initiates the transfer with this command. This is re-confirmed, then the requested data value is transferred.

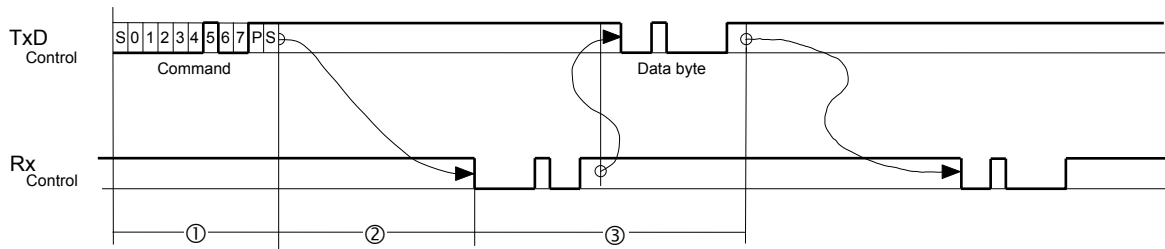

- ① Byte transfer time: 290 µs
- ② Delay: max. 4500 µs
- ③ Total transfer time: max. 5370 µs

### 5.1.2 „**BeamStream**“ – Format of Serial Data Transmission

This format represents a special type of data transmission via the serial interface. Its purpose is to show the **condition of each individual beam**, independent of Smoothing, Threshold and Data Mode.

Each bit of this “Beamstream” constitutes a beam. An interrupted („dark“) beam is represented by a logic „0“ and an uninterrupted („clear“) beam is represented by a logic „1“. As the UART transmits the DATA in form of Bytes, the Beamstream is transmitted in packages of 8 bits.

For a scanner with, e.g. **44 beams, 7 consecutive bytes** will be transmitted. The first byte, following the Echo, contains the information for the beams 1 - 8, the consecutive bytes beams 9 - 16 and so forth. Within one byte the lower digit represents the lower beams (in number). Not „occupied“ bits will be sent as logic „1“.

The control initiates the data transfer with the command **dx84**. This will be confirmed by a command echo, followed then by the requested Beamstream.

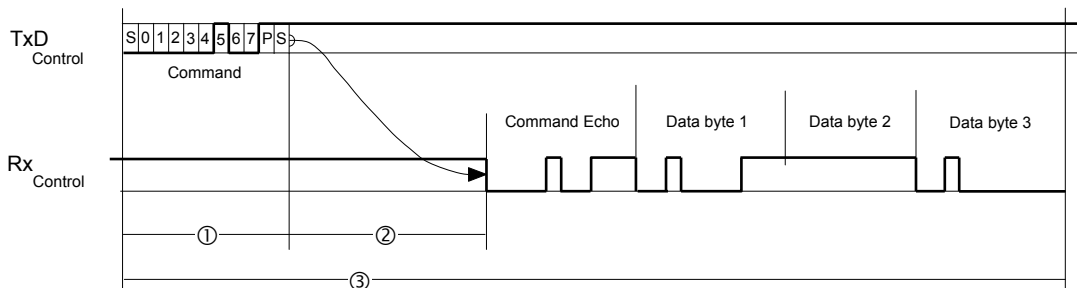

- ① Byte transfer time (at **38400 Bd**): 290 µs
- ② Delay: max. 4500 µs
- ③ Total transfer time (44 beams): max. 7020 µs

For a data transfer in „real time“ (transfer of every one measuring cycle), the data rate of the interface must be set to 230400 Baud (bps)!



For output in the **BeamStream** format, the scanner must be set to **Beam Count**.

### 5.1.2 Command Group *write\_configuration\_data*

As described previously, the command byte has to be sent by the controller first. Once the receiver has returned the echo, the desired new configuration data value - which is also returned as an echo - must be transmitted within approx. 1 - 2.5 ms.

Command	Hex code	Valid data range	Remarks
<i>write_receiver_gain</i>	10h	0...7	Setting receiver gain value, 8 steps
<i>write_emitter_gain</i>	D0h	0...3	Setting emitter power, 4 steps
<i>write_smoothing</i>	11h	1...254	Setting of SMOOTHING value
<i>write_first_led</i>	19h	0...254	Setting the offset for the beginning of the active scanning area. Offset 2 means, scanning starts at 3 <sup>rd</sup> LED
<i>write_last_led</i>	1Ah	0...254	Setting the offset for the end of the active scanning area. Offset 2 means, active scanning ends at the 94 <sup>th</sup> LED when the scanner comprises 96 diodes
<i>write_threshold_low</i>	1Bh	0...65535	Setting the low threshold value
<i>write_threshold_high</i>	1Ch	0...65535	Setting the high threshold value
<i>write_mode</i>	12h	1...15h	Setting the output format 0x01: Output mode: over_all, BCD code 0x02: Output mode: over_all, binary code 0x11: Output mode: over_all, Gray code 0x03: Output mode: normal, BCD code 0x04: Output mode: normal, binary code 0x13: Output mode: normal, Gray code 0x05: Output mode: largest_block, BCD code 0x06: Output mode: largest_block, binary code 0x15: Output mode: largest_block, Gray code
<i>write_result_type</i>	14h	0...1	Setting the output of measured data to be supplied as number of beams or as mm value. 0: output as number of beams 1: output as mm value

### 5.1.3 Command Group *read\_configuration\_data*

In accordance with the protocol, the command byte is sent first by the controller. Once the receiver has returned the echo, the current configuration data value is immediately transmitted by the receiver.

Command	Hex code	Valid data range	Remarks
<i>read_receiver_gain</i>	20h	0...7	Read current receiver gain value
<i>read_emitter_gain</i>	D8h	0...3	Read current emitter power value
<i>read_smoothing</i>	21h	1...254	Read current SMOOTHING value
<i>read_first_led</i>	29h	0...254	Read offset of begin of active scanning area
<i>read_last_led</i>	2Ah	0...254	Read offset of end of active scanning area
<i>read_threshold_low</i>	2Bh	0...65535	Read low threshold value
<i>read_threshold_high</i>	2Ch	0...65535	Read high threshold value
<i>read_mode</i>	22h	1h...15h	Read set output format 0x01: Output mode: over_all, BCD code 0x02: Output mode: over_all, binary code 0x11: Output mode: over_all, Gray code 0x03: Output mode: normal, BCD code 0x04: Output mode: normal, binary code 0x13: Output mode: normal, Gray code 0x05: Output mode: largest_block, BCD code 0x06: Output mode: largest_block, binary code 0x15: Output mode: largest_block, Gray code
<i>read_resolution</i>	23h	0...1	0: scanner has 2.5 mm resolution 1: scanner has 5 mm resolution 2: scanner has 10 mm resolution
<i>read_error</i>	88h	0...255	Read error codes
<i>read_result_type</i>	24h	0...1	Read current measuring data mode 0: output as number of beams 1: output as mm value
<i>read_release</i>	27h	-	Release number of software (hex value)
<i>read_diod_count</i>	25h	1h...ffffh	Number of diods (not beams!)



### 5.1.4 Command Group *read\_datasets*

Command	Hex code	Valid data range	Remarks
<i>Read_all</i>	81h	-	Read DATA and POSITION. 1st data byte: DATA, lo 2nd data byte: DATA, high* 3rd data byte: POSITION, lo 4th data byte: POSITION, high
<i>Read_data</i>	82h	-	Read DATA. 1st data byte: DATA, lo 2nd data byte: DATA, high*
<i>Read_pos</i>	83h	-	Read POSITION. 1st data byte: POSITION, lo 2nd data byte: POSITION, high

\* The data byte DATA, high also contains the information LAST\_LED as bit 7 (MSB) and the information FIRST\_LED as bit 6.

### 5.1.5 System Commands

The commands in this group only consist of the command itself. The command is in turn confirmed by the measuring system.

Command	Hex code	Valid data range	Remarks
<i>change_baudrate</i>	00h	-	The control sends the command 00h using the desired Baud rate. 9600 Baud, 19200 Baud and 38400 Baud are supported. If the scanner has already set the correct baud rate, it sends a 00h echo in response. Otherwise, the receiver increments / decrements the set baud rate by 1 increment and re-initialises the UART (≈ 2s). As a result, the scanner sends the 00h echo in response after a maximum of 3 increments.
<i>reset_scanner</i>	8fh	-	The receiver is re-initialised (≈ 3s). At the same time, the configuration values are reloaded from the EEPROM.
<i>reset_error</i>	89h	-	Reset all error codes
<i>restore_defaults</i>	8Eh	-	Restore factory settings
<i>store_config</i>	80h	-	This command saves the current configuration data in the EEPROM <sup>13</sup> . This operation takes approx. 10 ms per data value. This concerns the following data values: 1. Gain 2. Smoothing value 3. Output mode 4. Output format (beams ↔ mm) 5. Baud rate

<sup>13</sup> Note the limited programming life of the EEPROM (it can be reprogrammed approx. 100,000 times).

### 5.1.6 ScanView Software

By means of this software it is possible to program all aforementioned parameters via the serial interface of the scanner and a temporarily connected PC/Laptop/Notebook. For this purpose an interface cable connecting the scanner with the serial interface of the PC is required.

The following image shows the **ScanView** main menu. A more detailed description of the functions you can find in the manual. The **ScanView** software, as well as the manual you can download from our homepage

[www.sitronic.at/service/service\\_dl.php4?sprache=en](http://www.sitronic.at/service/service_dl.php4?sprache=en)

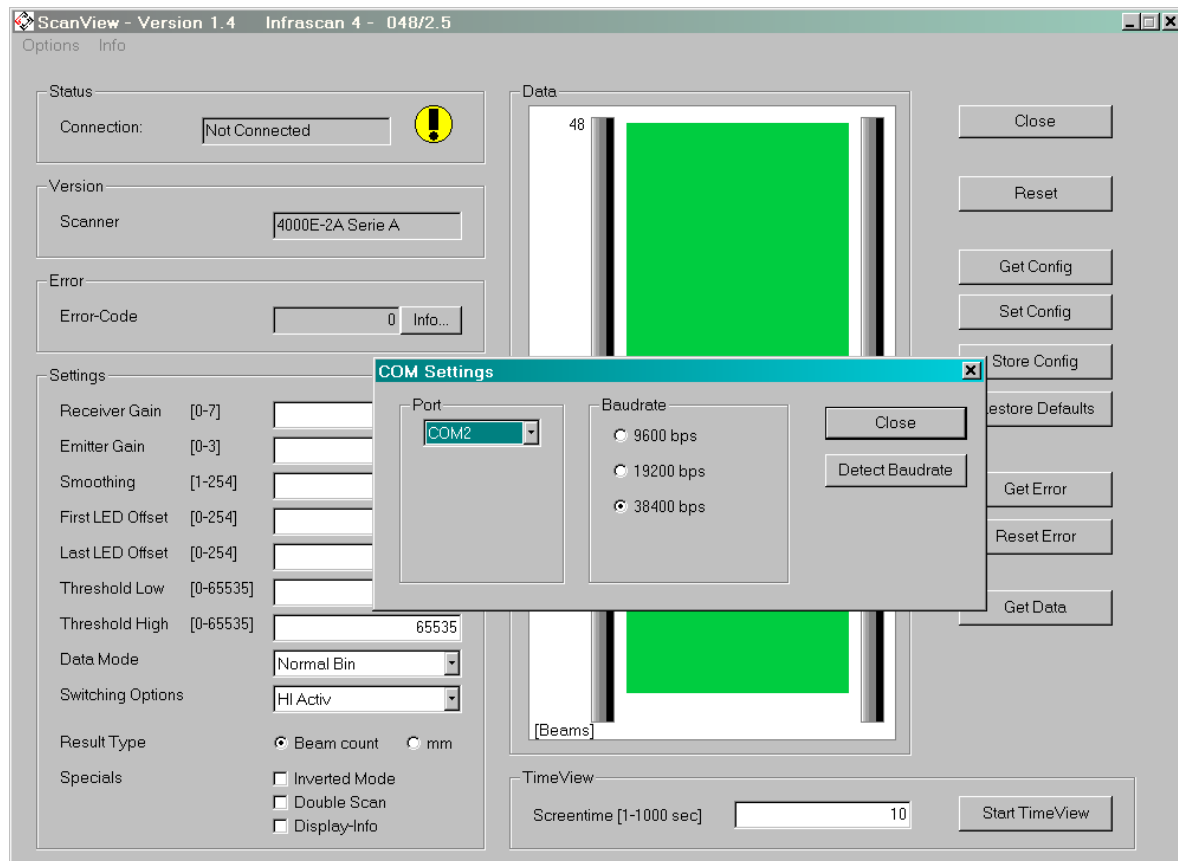

Conversion of the RS422 signal to an RS232C signal, required for the RS232C interface of the PC is performed in the housing of the connector on the PC. As a result, the signals are routed as immune RS422 signals along the entire cable and are not converted until they actually reach the connector housing.

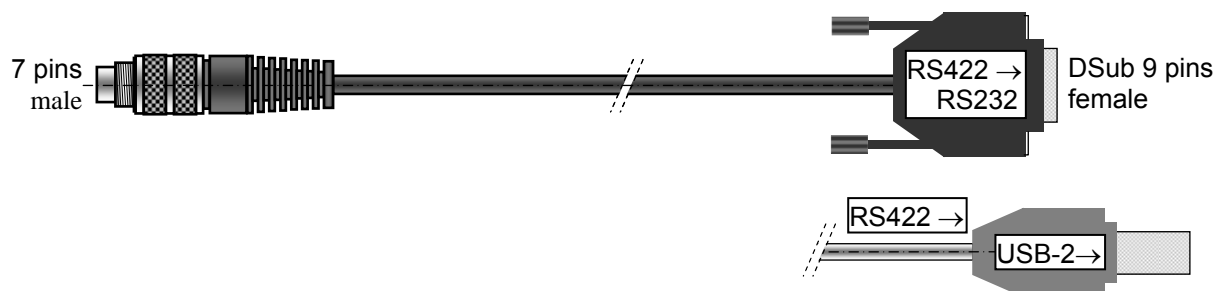

This interface cable must be ordered separately if it is needed (see also chapter 2.4 Ordering Code)

This interface cable is also available with USB-2 converter.

## 5.2 Switching Output

Signal	Cable
OUT	Black
GND	Brown

The output signal can be programmed to switch to „Hi“ or to „Low“. Moreover it should be observed that the output switches only when the number of *directly adjacent interrupted beams* exceeds the set **Smoothing** value. The same applies for a possibly set **Lower Threshold** value.

Smoothing Value	Measuring area	
	free	interrupted
Hi active	Hi	Lo
Lo active	Lo	Hi

By means of the **ScanView** software the switching mode can be programmed. Go to „**Switching Options**“ in the main menu, select from the list



and confirm by mouse click. With button **Set Config** the setting will be sent to the scanner, button **Store Config** will memorize it.

The *short circuit proof* output is equipped with a temperature sensor and supplies approximately 100 mA at a temperature of  $T_j = 25^\circ\text{C}$ .

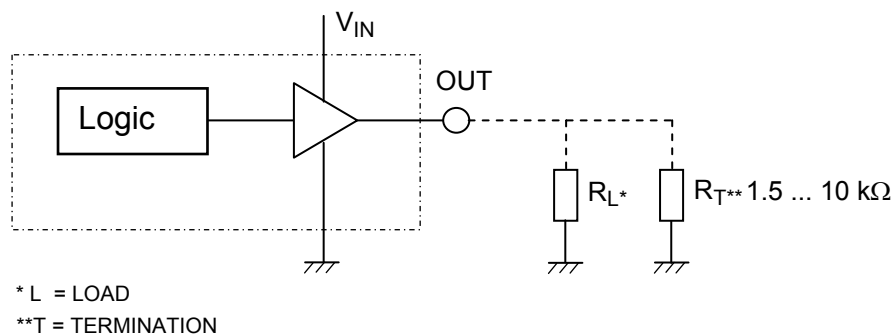

**Scanners are equipped either with Switching or Analog Output.**

**Depending on the hardware the ScanView menu will display „Switching Options“ or „Analog Options“**

## 5.3 Analog Interface

Signal	Cable
GND	Brown
I <sub>out</sub>	Blue
U <sub>out</sub>	White
DATA/POS	Black

The analog interface comprises the following signal lines:

### 1. I<sub>out</sub> - (OUTPUT):

On this line data will be output, if the interface is programmed to „**current output**“ (or was pre-programmed this way). In this case there are 3 options to choose from:

4-20 mA, 0-20 mA and 0-24 mA

### 2. U<sub>out</sub> - (OUTPUT):

On this line data will be output 0-10 V, if the interface is programmed to „**voltage output**“ (or was pre-programmed this way).

The interface can be programmed to output DATA or POSITION.

These settings can be adapted by means of the **ScanView** software. Go to „Analog Options“ in the main menu and select

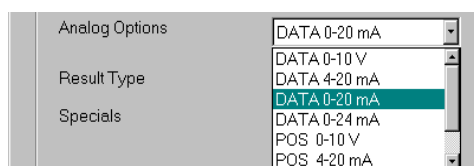

a suitable combination of:

**Current or voltage output,  
output of DATA or POSITION**

With button **Set Config** the selection is sent to the scanner, button **Store Config** will memorize the setting.

## Technical Data of Analog Output

Specification of **voltage output**:

R<sub>out</sub> = < 1 Ω, I<sub>out</sub> = 10 mA max.

Specification of **current output**:

Recommended load resistance

R<sub>L</sub> = ≥220 Ω ≤680 Ω

Output impedance

25 MΩ

Accuracy<sup>14</sup>

Monotonicity

16 bits

Integral non-linearity

typ. ±0.002, max. ±0.012 %

Offset (T<sub>A</sub> = 25°C)

±0.05 %

Offset drift

typ. 20, max. 50 ppm/°C

Total output error (T<sub>A</sub> = 25°C)

±0.15 %

Total output error drift

typ. 20, max. 50 ppm/°C

PSRR<sup>15</sup>

typ. 5, max. 10 μA/V

These data are based on the AD420 specification and are subject to change without notice.

<sup>14</sup> Total Output Error includes Offset and Gain Error. Total Output Error and Offset Error are with respect to the Full-Scale Output and are measured with an ideal +5V reference.

<sup>15</sup> PSRR (Power Supply Rejection Time) is measured by varying V<sub>CC</sub> from 12 V to its maximum 32 V

## 6. MULTI-DIRECTION OPERATION

### 6.1 Problem definition

So far only the function, installation and configuration of **one** scanner system have been dealt with. However, the **InfraScan®4000/10** measuring system also permits **multi-direction** measurement (e.g. horizontal and vertical at 90°).

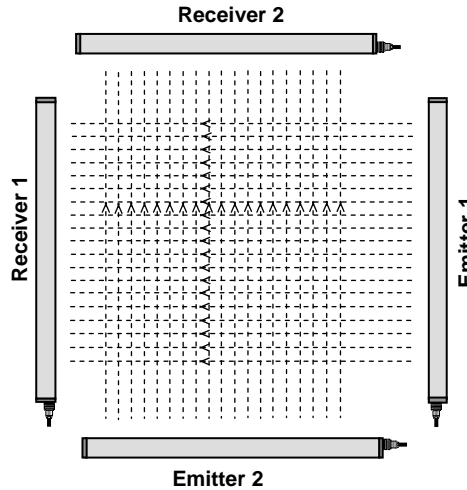

In such a measuring configuration problems may occur when light beams from emitter 1 are reflected onto receiver 2 or vice versa.

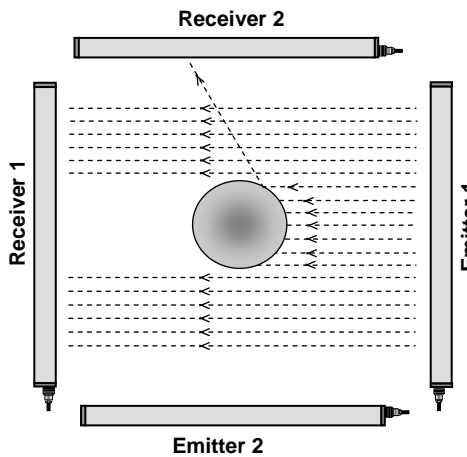

This type of interference may prevent effective application of the measuring system. For this reason, the emitters of the individual measuring directions must be **“sequenced”**. In other words, only one measuring level is active at a time.

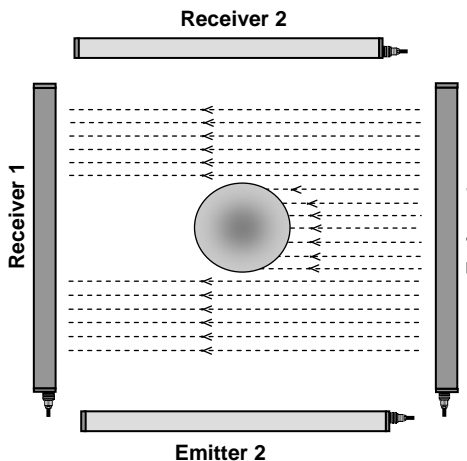

The next measuring level is not activated until the measuring cycle has been completed. As a result, interfering reflections cannot affect the remaining deactivated measuring scanners.

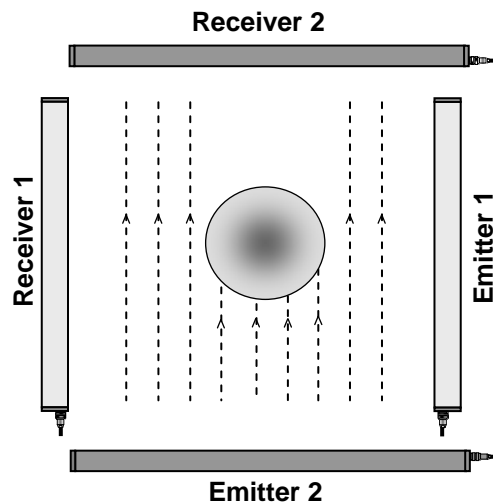

## 6.2 Sequencing signals

Each emitter provides sequencing signals for multi-direction measuring at the socket for connecting the voltage supply (8-pin plug).

Signal	Cable*
SEC-IN	White
/SEC-IN	Brown
SEC-OUT	Green
/SEC-OUT	Yellow
+ 24 V	Pink
GND	Grey

### 1. SEC-IN, / SEC-IN (Input):

The emitter can be activated and de-activated via these differential input signals (RS-422 standard). They are scanned at the beginning of each measurement cycle.<sup>16</sup>

- SEC-IN = 1 and / SEC-IN = 0 ⇒ Emitter active
- SEC-IN = 0 and / SEC-IN = 1 ⇒ Emitter inactive

### 2. SEC-OUT, / SEC-OUT (Output):

After every complete measurement cycle, the emitter outputs a pulse via these differential signals (RS-422 standard), activating the downstream measuring system currently in the wait state.

<sup>16</sup> When in progress, a measuring cycle cannot be interrupted.

### 6.3 Commissioning a multi-direction measuring system

The signals the emitter provides for sequencing are already conditioned to operate a multi-direction measuring system. Each INFRASCAN®5000 scanner is already designed for this mode of operation, i.e. no auxiliary unit is required.

Install the systems of the individual levels according to the instructions given in Chapter 3. First install and adjust each system separately, then check the functioning of the individual systems.<sup>17</sup>

After this, make the additional connections for sequencing of the individual measuring levels (as shown below for the configuration of 3 measuring systems):

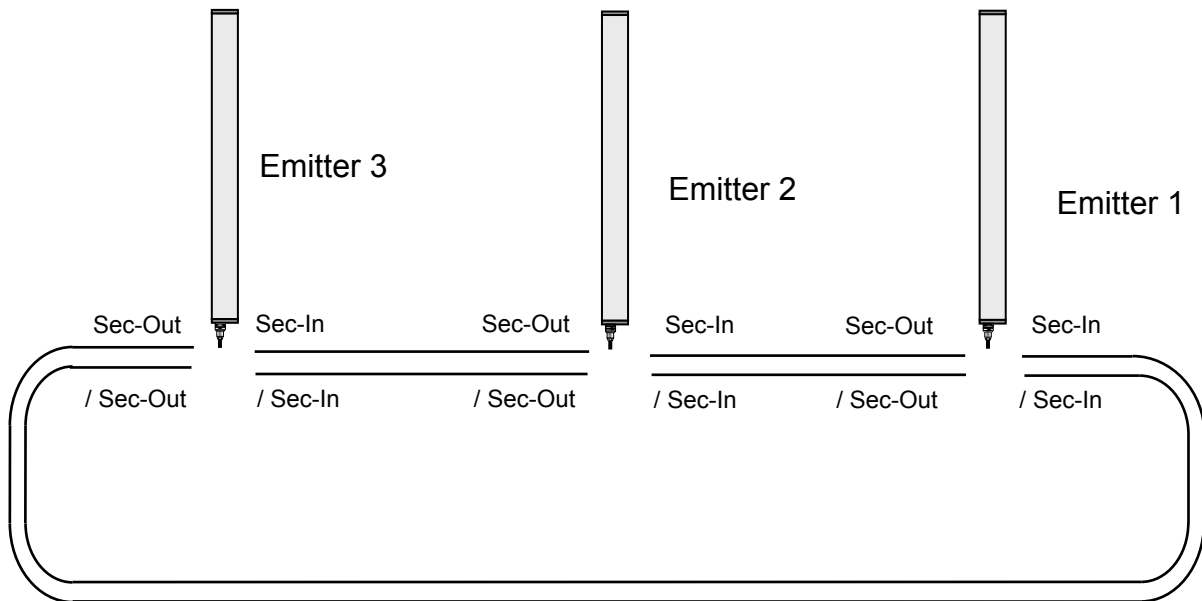

Connect the output sequencing signals of the emitters to the respective input sequencing signals of the downstream emitters to create a loop. This type of sequencing permits the operation of up to 6 scanners in the multi-direction mode.

**Note:** When the supply cables are very long, overloading of the sequencing in- and outputs may occur. In such cases it is recommended to keep the sequencing leads as short as possible and only to lead the power supply only over the long distance.

<sup>17</sup> All non-applicable measuring levels must therefore be switched off in order that interference from other levels can be eliminated with absolute certainty.

# 7. TECHNICAL DATA

## 7.1 Dimensions

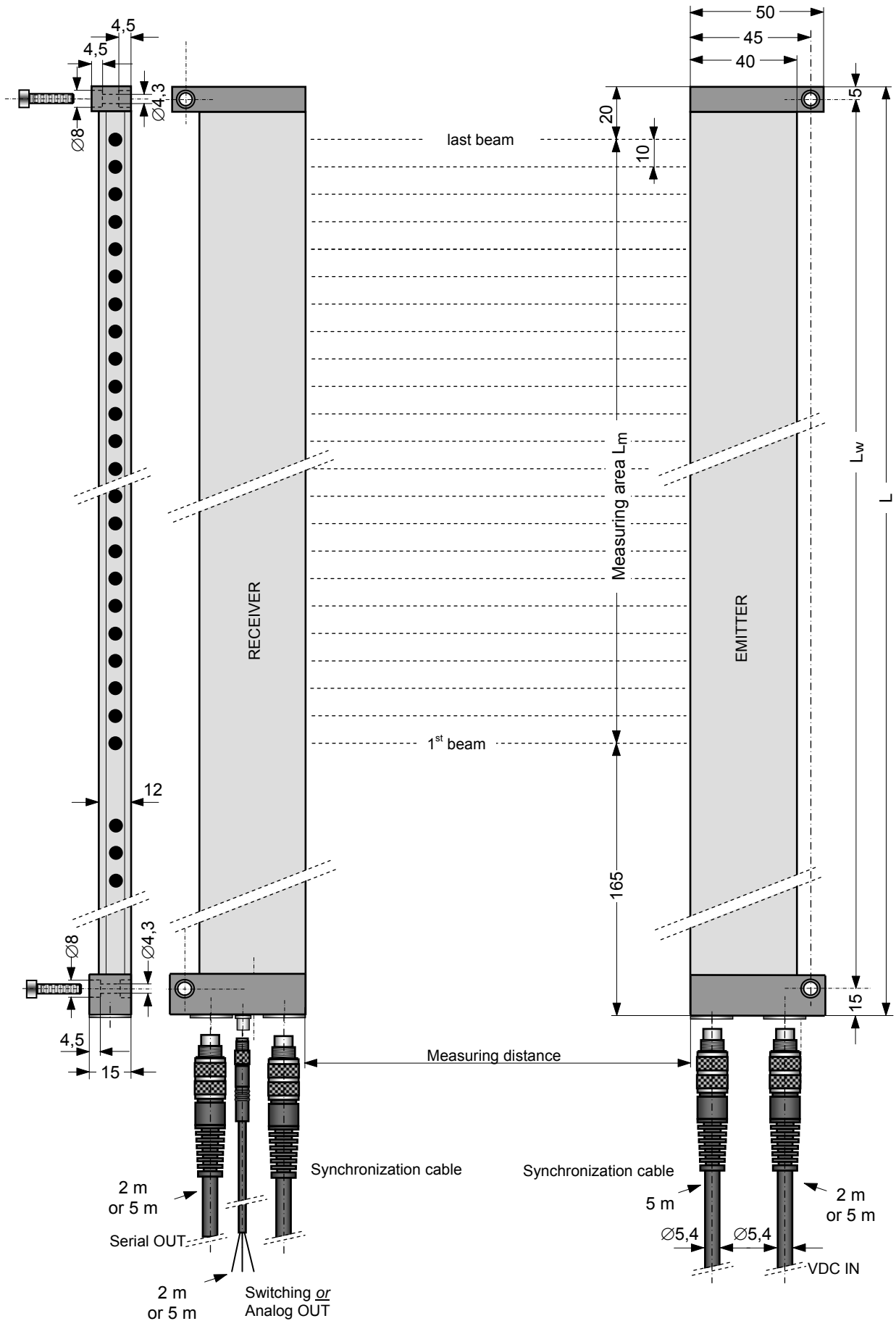



## 7.2 Dimensions modular

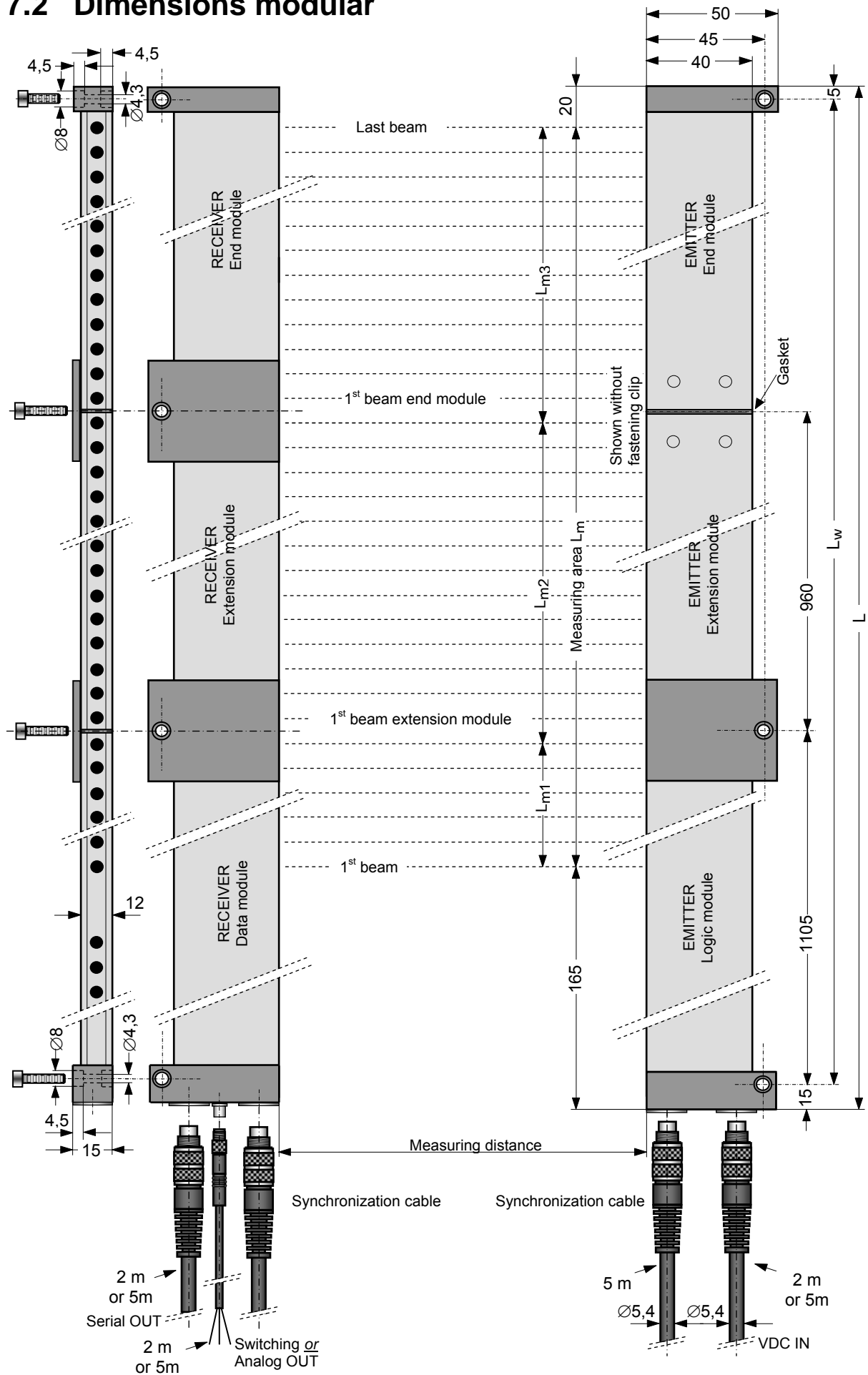

## 7.3 Standard types

The following types of series **InfraScan®4000/10** are available as standard:

Type	Beams	L <sub>m</sub> [mm]	L <sub>w</sub> [mm]	L [mm]	Cycle time [ms]	Weight [kg]*
4012/10	12	110	275	295	0,84	0.5
4016/10	16	150	315	335	0,84	0.55
4032/10	32	310	475	495	0,84	0.8
4048/10	48	470	635	655	0,84	1.05
4064/10	64	630	795	815	0,84	1.3
4080/10	80	790	955	975	0,95	1.55
4096/10	96	950	1115	1135	1,11	1.8
4112/10	112	1110	1275	1295	1,27	2.05
4128/10	128	1270	1435	1455	1,43	2.3
4160/10	160	1590	1755	1775	1,75	2.8
4188/10	188	1870	2035	2055	2,03	3.0
4192/10	192	1910	2075	2095	2,07	3.1
4204/10	204	2030	2195	2215	2,19	3.3

## 2. Scanner with Double Scanning<sup>18</sup> Resolution 5 mm<sup>19</sup>

Type	Anzahl Strahlen	L <sub>m</sub> [mm]	L <sub>w</sub> [mm]	L [mm]	Zykluszeit [ms]	Gewicht [kg]*
4012/10	23	110	275	295	0,84	0.5
4016/10	31	150	315	335	0,84	0.55
4032/10	63	310	475	495	0,84	0.8
4048/10	95	470	635	655	1,10	1.05
4064/10	127	630	795	815	1,42	1.3
4080/10	159	790	955	975	1,74	1.55
4096/10	191	950	1115	1135	2,06	1.8
4112/10	223	1110	1275	1295	2,38	2.05
4128/10	255	1270	1435	1455	2,70	2.3
4160/10	319	1590	1755	1775	3,34	2.8
4188/10	375	1870	2035	2055	3,90	3.0
4192/10	383	1910	2075	2095	3,98	3.1
4204/10	407	2030	2195	2215	4,22	3.3

All dimensions in mm  
Drawings not to scale!

\*Emitter and receiver, without cables

<sup>18</sup> Double Scanning is a firmware feature.

The ordering code only concerns the hardware and does not change.

<sup>19</sup> In the center of the measuring distance.

## 7.4 Technical Data

Housing material:	anodized aluminum window of glass protection IP 67
<b>OPTICAL DATA</b>	
Number of beams:	12 - 288
Beam spacing:	10/20 mm 5/10 mm with double scanning*
Measuring range:	110 – 2870 mm
Distance emitter ↔ receiver:	32 ranges from 0.2 – 4 m standard
Wave length:	880 ... 950 nm, infrared
<b>ELECTRICAL DATA</b>	
Power supply:	24 V ± 20%, ca. 1 A; max. ripple < 200 mV
Scanning frequency:	100 kHz
<b>DATA modes</b>	Normal, Largest Blocked Area, Over All, Smoothing 1 ... n
<b>Output modes:</b>	BINARY, BCD or GRAY coded, DATA and/or POSITION output In number of broken beams or in mm or in <b>BeamStream</b> format
<b>INTERFACES</b>	
<b>Serial UART interface:</b>	RS422 9.6 / 19.2 / 38.4 kBaud transfer rates 8 data bits 1 stop bit even parity converter to RS232 or USB-2 available
<b>Switching output:</b>	PNP, open collector, max. 100 mA short circuit proof, load to GND
<b>Optional:</b>	
<b>Analog output:</b>	Programmable by software
Voltage output:	0-10 V or <b>alternatively</b>
Current output:	4-20 mA, 0-20 mA, 0-24 mA DATA or POSITION
<b>Control inputs:</b>	
DATA or POSITION	24 V, ca. 3 mA at 24 V
Storage temperature:	-40°C ... 80°C
Ambient temperature:	-25°C ... 50°C

*\*In the center between emitter and receiver  
Specifications are subject to change without notice.  
Edition 1.33– 2012-01-30*